

STAR WARS

GALAXY GUIDE 9 FRAGMENTS FROM THE RIM

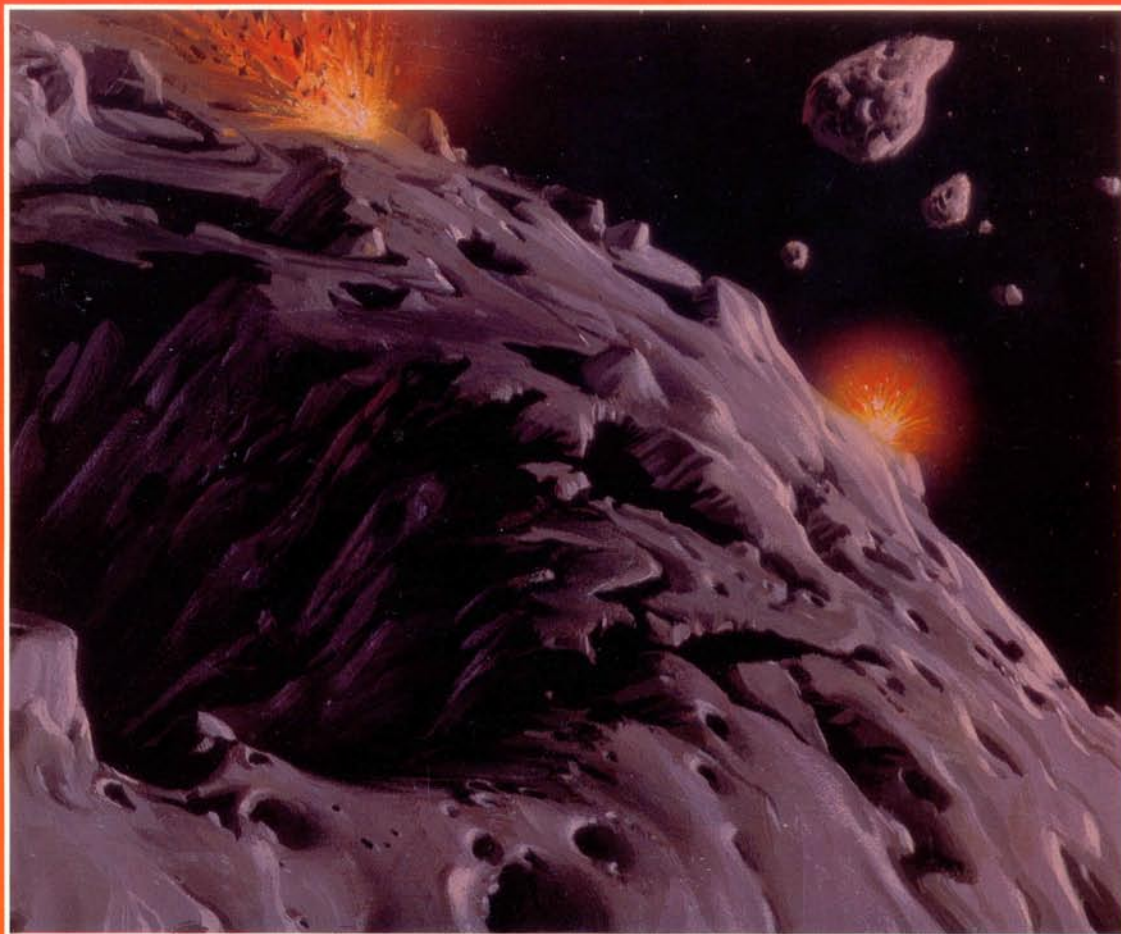

STAR WARS®

G A L A X Y G U I D E 9 FRAGMENTS FROM THE RIM

by Simon Smith and Eric Trautmann



Development and Editing: **Bill Smith**
Graphics: **Cathleen Hunter** • Cover Art: **Lucasfilm Ltd.**
Interior Art: **Mike Vilardi**

Publisher: **Daniel Scott Palter** • Associate Publisher/Treasurer: **Denise Palter**
Associate Publisher/Sales Manager: **Richard Hawran** • Senior Editor: **Greg Farshtey**
Editors: **Bill Smith, Ed Stark** • Art Director: **Stephen Crane**
Graphic Artists: **Cathleen Hunter, John Paul Lona** • Sales Assistant: **Bill Olmesdahl**
Licensing Manager: **Ron Seiden** • Warehouse Manager: **Ed Hill**

Published by



RR 3 Box 2345
Honesdale PA 18431

40063

Introduction

Galaxy Guide 9: Fragments From The Rim is a compilation of facts, feats, backgrounds and information for use with *Star Wars: The Roleplaying Game, Second Edition*. It is intended to be used by gamemasters for background atmosphere in their campaigns, and it is also intended to be inspirational. This accessory provides a mixed bag of *Star Wars* guilds, Rebels, Imperials, bounty hunter syndicates, prominent bands, criminals and crime bosses, exotic locations and tourist traps, new Force skills, and even common beverages of the Outer Rim Territories to add detail and realism to your campaign.

Having seen the "model" write-ups contained in *Fragments*, gamemasters should find it much easier to generate similar material of their own, or adapt the contents to serve their own adventures. Each example included in *Fragments* has a brief description, to help gamemaster's capture the *Star Wars* "feel" when using the items in their own campaign. The individual entries are not carved in stone, however. A gamemaster can use each entry as it stands or modify as much as needed to help add some color to a gaming session.

The Outer Rim Territories

"Well, if there's a bright center to the universe, you're on the planet that it's farthest from."

— Luke Skywalker

The above sentiments expressed by Luke Skywalker about his homeworld of Tatooine are a brief and fairly accurate summary of the Outer Rim Territories. The Outer Rim Territories form the boundary of one edge of space currently controlled by the Empire. Since the days of the Old Republic, the Outer Rim region has been wild, untamed — the galactic frontier.

However, since the recent boom in exploration, the area has steadily become more and more civilized, though much is still unexplored and wild. The more affluent Core World citizens tend to take holidays in the more developed systems of the Outer Rim Territories "to get away from it all."

The Rebellion found much of its early support in the Outer Rim Territories, as the Empire considered the region good for little else other than exploitation. Some of the more infamous atrocities the Empire has committed have been in the Outer Rim Territories because there aren't many people around to see and report on such activity. The region is isolated enough that word of these actions will seldom reach the Core Worlds.

The Outer Rim Territories encompass a vast tract of space, and rather than give a detailed analysis of the area as a whole, the "fragments" within are, for the most part, located in the same general area, namely the Parmel, Quence, Parmic, and Portmoak Sectors. These sectors are fairly representative of the Outer Rim Territories.

Time Frame

Galaxy Guide 9: Fragments From The Rim is set in the period of time following the destruction of the Empire's first Death Star, but before the Battle of Endor. At present, the second Death Star is in the preliminary stages of development. Darth Vader and the Emperor are both still alive, the Rebel Alliance is fleeing the Imperial fleet by hiding in the backwaters of the galaxy, and the few Jedi Knights who remain are still being actively sought and exterminated by the forces of the Emperor.

What this means to the traditional *Star Wars* campaign is that the player characters will have to keep their true feelings quiet. However, because of the kinds of atrocities that have been committed in this region of space, very few beings are loyal to the Empire. Fearful of the Empire, yes. Loyal, no.

Characters could, with some careful maneuvering, turn this area of space into a hotbed of rebellion. Much as Tatooine seemed isolated from the goings-on of the rest of the galaxy, so will most Outer Rim worlds be relatively unruly. The Rebellion could gain much here, and smugglers have much greater freedom than in other regions of space.

Chapter One

Rebel Operatives

The following collection of Rebel operatives provides a number of contacts for player characters involved in the Rebel Alliance. These characters will be familiar to Rebels throughout the Outer Rim Territories, and may even be known to local crime figures, corporate officials or the forces of the Empire.

Corwin Shelvay

Jedi Master Darrin Arkanian was an idealist and a dreamer. The Sullustan Jedi had learned to cherish life and tried to make his existence a model of peace and contemplation. Despite the rise of the Emperor and his despotic policies, he convinced himself that there would be no major threat as long as he and his fellow Jedi trusted in the Force. As time went on, Arkanian realized his error in judgement as the Jedi were hunted down.

Eventually, he took a dedicated apprentice, a young man named Corwin Shelvay. Shelvay was full of good intentions, but he was also easy to anger. Corwin tried to convince his Master to lead the fight against the Empire, while Arkanian fought to teach the young Jedi how to control his emotions.

As fugitives, Arkanian and Shelvay roamed the galaxy, trying to unite the scattered fragments of the Jedi Knights as the Emperor continued his campaign against the former guardians of the Republic.

Eventually, Shelvay was captured by the Imperials, but their interrogators could not force him into revealing the location of Arkanian. Finally he was turned over to Imperial High Inquisitor Tremayne, and underwent two weeks of intensive Imperial torture and coercion on Coruscant.





Corwin Shelvay

Type: Jedi Turned Rebel Operative

DEXTERITY 4D

Blaster 5D, dodge 6D, melee combat 4D+2, melee parry 4D+2, lightsaber 5D+2

KNOWLEDGE 2D

Alien species 4D+2, streetwise 5D, survival 5D+2, willpower: torture 8D+2

MECHANICAL 2D

Space transports 5D+2, starship gunnery 5D+2

PERCEPTION 3D

Con 5D, hide 5D+2, search 5D+2, sneak 7D

STRENGTH 2D+2

Brawling 6D+2, stamina 6D+2

TECHNICAL 2D

Lightsaber repair 6D+2

Special Abilities:

Force Skills: Control 3D, sense 3D

Control: Accelerate healing, control pain, hibernation trance, reduce injury, remain conscious, resist stun

Sense: Magnify senses

Control and Sense: Lightsaber combat

This character is Force-sensitive.

Force Points: 5

Character Points: 15

Move: 10

Equipment: Lightsaber (5D damage), clothes, datapad, blaster pistol (4D damage), macrobinoculars

Somehow (and even Shelvay doesn't know how) he managed to withstand the cruelty of the High Inquisitor, until Arkanian rescued him.

Finally, as they were fleeing Coruscant, Arkanian faced Tremayne in a fierce lightsaber duel, which Arkanian lost. At the sight of his Master being severely injured by Tremayne, Shelvay attacked the Inquisitor with a ferocity that was incredible from one so young. Enraged, he severed Tremayne's arm and damaged his face, and finally fled with Arkanian, who died a few days later.

After the battle with Tremayne, Shelvay realized he had touched the Dark Side of the Force to defeat the Inquisitor, and if he had slain the Dark Jedi he would have firmly placed himself on the path of evil. In a vision, he saw himself becoming a twin of Tremayne's, and this shocked him out of the Dark Side's grasp. He is very cautious in the use of his Force powers, always conscious of the Jedi Code.

After Arkanian's death, Shelvay, a fugitive from the forces of the Empire, tried to return to his home, but found it deserted. He has since discovered that the Empire killed his family except for his sister, Elena (who has been indoctrinated into COMPNOR and is actively seeking Corwin's capture). That was over a decade ago.

In the years since, he has wandered the Outer Rim Territories, never staying in any one place

for too long. He was a Jedi adrift from the Force, and fearing that he would never learn his purpose in life. Then he met Devon Fuller, who introduced him in turn to contacts in the Rebel Alliance. Corwin has joined the Rebels, and has proven an invaluable operative and recruiter.

Corwin Shelvay looks much older than he actually is. He is one of the few people who has withstood an interrogation by Imperial High Inquisitor Tremayne, and the experience had a profound effect on him. His hair is beginning to grey prematurely, and he rarely smiles. He is courteous, polite and in all ways embodies the spirit of the Jedi Knights, though he regrets that he never got a chance to complete his training under Jedi Master Darrin Arkanian.

Shelvay typically wears grey pants and a grey tunic, with a black vest over it. He sometimes wears a long grey trench coat if he wants to conceal his identity. Shelvay's attitude changed after the encounter with Tremayne. As he is fond of saying, "The Force always shows you the right path ... but nothing says that the path will be easy."

Devon Fuller

Fuller resembles a rather lightweight, brash pilot type, seemingly more at home in the cockpit of an X-wing than a beat-up tramp freighter. Though he still retains some of the boyish good looks of his youth, work for the Rebel Alliance has left him physically marked, but with a new aura of determination. He usually wears a worn flight jacket and steelcloth heavy duty trousers. He also wears a battered Imperial captain's cap that he "procured" in one of his many misadventures.

Fuller, despite his professed allergy to all matters philosophical, was recently forced to take a good look at exactly what he wanted from life. He was converted to believing in the Force by Corwin Shelvay ("The hard way, but don't ask!") — the last thing he wanted was to have his motivations brought out into the open.

At his worst, Fuller is cynical, mercenary, selfish and over-confident ("Talk is cheap. Drinks cost *money*"). He is honest about the con man side of his personality, making him instantly charming *and* untrustworthy ("Anyone for an honest game of chance? No? Me neither. Play, and I'll raise you fifty.").

Despite this, he will go a long way to help his friends, even if he does cook up some other "economically sound" reason to go after them. It's true that he does try to keep the numbers of his closer friends down so that this tedious conscience of his doesn't get too many chances to nag him, but he still has a fair number of allies throughout the galaxy.

IMPERIAL CRIMINAL DOSSIER

FILE REF: #79/35/CF/50.272

NAME: Devon Fuller

SPECIES: Human **SEX:** Male

AGE: 40 (Believed)

HOMEWORLD: Arkanis

KNOWN ASSOCIATES:

Corwin Shelvay, Davaire Colmar,
Davar Hamalcal

CRIMES AGAINST THE EMPIRE:

- Accomplice to Murder
- Aiding and Abetting Known Traitors
- Aggression Against a Member of the Imperial Armed Forces
- Assault of an Imperial Officer
- Assault with Intent to Injure
- Breach of the Peace
- Breaking Into an Imperial Installation
- Breaking Out of an Imperial Installation
- Carrying a Concealed Weapon
- Carrying an Illegal Weapon
- Conspiracy
- Drunk and Disorderly Conduct
- Failure to Obey the Imperial Navy
- Falsifying Documents
- Forgery
- High Treason
- Illegal Gambling
- Impersonating an Imperial Officer
- Jamming Imperial Communications
- Membership in an Illegal Organization
- Murder
- Obstructing the Course of Justice
- Operating an Illegally Modified Starship
- Operating an Unregistered Starship
- Piloting a Repulsorlift Vehicle Without Due Care and Attention
- Piloting a Starship Without Due Care
- Possession of Stolen Goods
- Reckless Endangerment
- Resisting Arrest
- Sabotage
- Smuggling
- Theft
- Transportation of Illegal Aliens
- Transportation of Stolen Goods
- Transportation of Restricted Items
- Trespassing on Imperial Property
- Trespassing on Private Property
- Unauthorized Review of Imperial Data Files
- Violation of Imperial Customs Regulations
- Willful Destruction of Imperial Property

BOUNTY: 40,000 Credits



#79/35/CF/50.272

BOUNTY:

Devon Fuller has shown himself to be a ruthless and highly skilled operative for the Rebel Alliance. Fuller is invariably armed and should be approached with due caution.

Fuller is a skilled pilot, astrogator and gambler, as well as a crack shot with a blaster. The Imperial High Inquisitor Tremayne has also indicated that Fuller is "strong in the Force" (and has subsequently required this information to be included in his dossier).

Five independent sources also offer rewards for his capture. The magnitude of these rewards are not known, but serve as a good indication of this criminal's activities and value to the Empire for interrogation purposes.

If he or any of his known associates are seen, notify the appropriate authorities immediately. Anyone providing information leading to his capture will be well-rewarded.

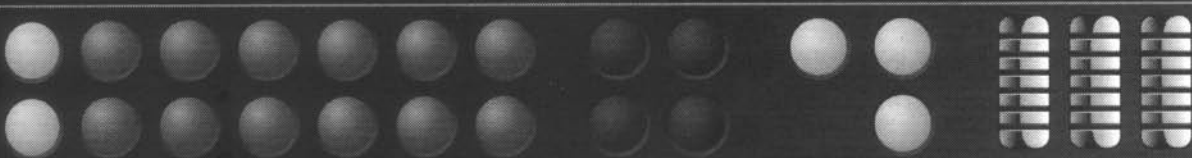

Devon Fuller**Type:** Smuggler**DEXTERITY 3D+1**

Blaster 6D, dodge 4D

KNOWLEDGE 2D+1

Bureaucracy 2D+2, planetary systems 3D, streetwise 3D, survival 3D

MECHANICAL 3D+2

Astrogation 6D, repulsorlift operation 4D, sensors 4D, space transports 7D, starship gunnery 5D, starship shields 4D

PERCEPTION 3D

Forgery 4D, gambling 6D

STRENGTH 3D**TECHNICAL 2D+2**

First aid 4D, space transports repair 3D+2

Force Points: 3**Character Points:** 18**Move:** 10**Equipment:** Heavy blaster pistol (5D damage), hold-out blaster (3D+2 damage), 2 medpacs, modified Ghtroc light freighter (*The Solar Flair* — see below)**The Solar Flair****Craft:** Ghtroc Industries class 720 Freighter**Type:** Modified light freighter**Scale:** Starfighter**Length:** 35 meters**Skill:** Space transports: Ghtroc freighter**Crew:** 1; 1 can coordinate; gunners: 2**Crew Skill:** See Devon Fuller**Passengers:** 10**Cargo Capacity:** 135 metric tons**Consumables:** 2 months**Cost:** 45,000**Hyperdrive Multiplier:** x1.5**Hyperdrive Backup:** x15**Nav Computer:** Yes**Maneuverability:** 1D**Space:** 4**Atmosphere:** 280; 800 KMH**Hull:** 4D**Shields:** 1D**Sensors:***Passive:* 15/0D*Scan:* 30/1D*Search:* 50/3D+2*Focus:* 3/4D+2**Weapons:****Two Twin Laser Cannon***Fire Arc:* Turret*Crew:* 1*Skill:* Starship gunnery*Fire Control:* 2D*Space Range:* 1-3/12/30*Atmosphere Range:* 100-300/1.2KM/3KM*Damage:* 4D+1

Capsule: The *Solar Flair* is a typical freighter that has been heavily modified over its years of service. No one knows how it came into the hands of the Alliance, but now that Devon Fuller has control of the vessel, it is getting the workout of its career. Devon always gives 110%, and expects the same of his equipment. As a result, the *Flair* is consistently pushed beyond its specifications, tackling flights of TIE fighters, racing Imperial customs frigates and trying to blast through pirate blockades. Somehow, the ship has held together despite the fact that Fuller has never heard of "preventative maintenance."

He was expelled from the Vensenor Flight Academy, served as navigator on a Corellian Corvette, ran his own botched gem-smuggling operation (escaping Imperial capture by a matter of minutes), and basically has made a nuisance of himself on hundreds of backwater worlds. Fuller eventually bought a small freighter called the *Croc of Gold*. He spent a couple of years trading (in legal goods, for a change) and made friends with a Rebel agent named Owen Sareth. Owen's help was invaluable in Fuller's trading endeavors (he's a *lousy* businessman) but led to Fuller's involvement with the Rebel Alliance. Owen has also given him a new curse to add to his already colorful vocabulary: "This is all Owen's fault!"

Since joining up with the Alliance, his ships tend to get blown up at a frightening rate. Fuller is now on his third ship. The *Croc of Gold* was shot out from under him by Imperials over Tashtor Seneca. His second ship, the *Freebooter*, was wrecked by a Star Destroyer attacking the Ansarra Rebel base. *The Solar Flair* is on loan from the Rebel Alliance, with explicit instructions to *take care of it*. Since it's *their* fault he has lost two of his own craft, he isn't being all that careful, however.

Fuller came to realize that the one thing he values more than any other is freedom, despite his protests that money is his major motivator. It is this love of freedom, and his realization that the Empire is systematically curtailing it, that has kept him with the Rebel Alliance.

Thila

Thila is a jowled, mouse-eared female Sullustan, with a hunched posture and a sour disposition. Very little is known of the slaver Thila. She began making herself known about 15 years ago, buying a small number of slaves that were never resold. Within a month, however, the appearance of the infamous "Rancor Holos" from Jabba's palace began selling like wildfire in the underground holofeature market. Thila was suddenly *very* rich. Presumably these slaves were Rancor-fodder for Jabba, or so the rest of the galaxy believes, and she is more than willing to play up this story ("While I'm here, you wanna buy some banned holos? Bloody stuff, mostly. Do you have market contacts for that kind of stuff?").

Thila's outward behavior is coarse, foul-tempered, mercenary and cynical. She treats the slaves she buys like cattle or any other commodity ("I'm real sorry, pal, but the ones I buy never make it to the *second-hand* market."). She is known to take almost any slave if the price is right, and her cargos seem to disappear without a trace ("See that old crone on the end? The fat one, shivering? Eating into your profits, is she? No one else'll buy her, but I can dispose of her for

The Arkanian Dawn

The Arkanian Dawn

Craft: Y164 Thalassian slave transport
Type: Modified medium slave transport
Scale: Capital
Length: 90 meters
Skill: Space transports: Y164 Thalassian slave transport
Crew: 5; 1 can coordinate; gunners: 2; support (for slaving): 8
Crew Skill: See Thila and Matt Talon
Passengers: 12,400 (slaves)
Cargo Capacity: 10 metric tons
Consumables: 1 month
Cost: 245,000
Hyperdrive Multiplier: x3
Hyperdrive Backup: x25
Nav Computer: Yes
Maneuverability: 1D
Space: 1
Atmosphere: 210; 600 KMH
Hull: 2D
Shields: 2D
Sensors:
Passive: 10/0D

Scan: 25/1D
Search: 45/3D
Focus: 3/4D

Weapons:

Two Quad Laser Cannon

Fire Arc: Turret
Crew: 1
Scale: Starfighter
Skill: Starship gunnery
Fire Control: 1D+1
Space Range: 1-3/12/25
Atmosphere Range: 100-300/1.2KM/2.5KM
Damage: 5D

Capsule: The *Arkanian Dawn* is one of the most infamous slaving vessels in the Outer Rims. The sight of the vessel coming down in a slave camp is enough to strike terror into the hearts of beings everywhere. The *Dawn's* reputation is that of a death ship; one that takes slaves who are never seen again. It is only when slaves are aboard and on their way to freedom that they learn that the vessel will be their salvation, not their death.

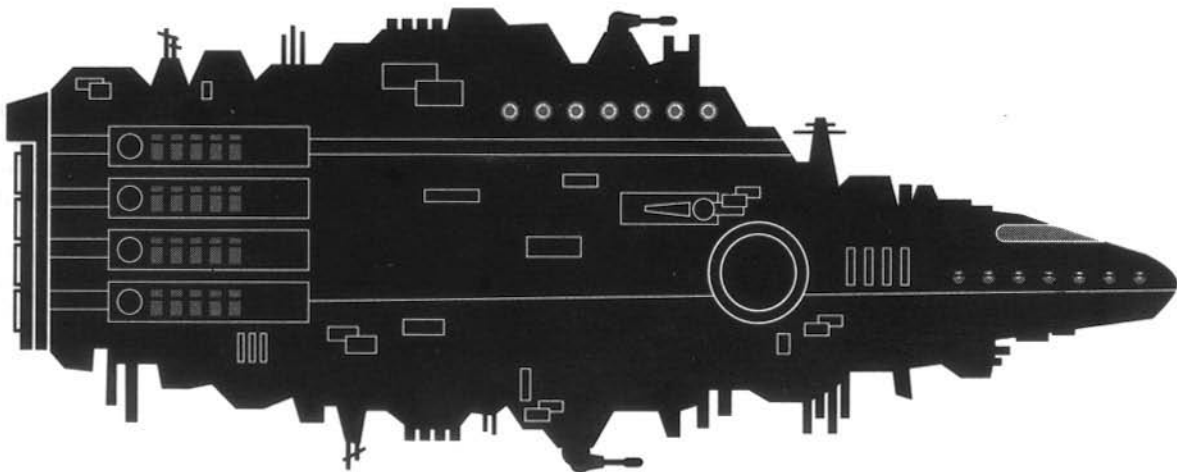



Thila

Type: Slaver/Rebel Operative

DEXTERITY 2D+1

Blaster 4D+1, dodge 3D+1, melee combat 4D+1

KNOWLEDGE 2D+1

Intimidation 6D, languages 3D, streetwise 5D+2

MECHANICAL 3D+2

Astrogation 4D+2, space transports 5D+2

PERCEPTION 3D+1

Bargain 4D+2, con 4D+2

STRENGTH 2D+2

Stamina 4D

TECHNICAL 3D+2

Special Abilities:

Enhanced Senses: Sullustans have ad-

vanced hearing and vision. Whenever they make *Perception* or *search* checks involving vision in low-light areas, they get a +2D bonus.

Location Sense: Once a Sullustan has visited an area, she always remembers how to return to the area. When making an *astrogation* total for a place the Sullustan has previously visited, add +1D to the die roll.

Character Points: 6

Move: 10

Equipment: Heavy blaster pistol (5D damage), 2 magnetic binders, comlink, pain inducer (5D stun damage), Y164 Thalassian slave transport (*Arkanian Dawn* — see page 7).

Arkanian Dawn

The control cabin of a Y164 Thalassian slave transport is generally not a nice place. The cockpit of the *Arkanian Dawn* was particularly unappealing, littered with the detritus of too many long watches spent with too little to do, on a ship powered solely by greed and the misery of others. The floor was mired in a layer of food wrappers and miscellaneous shreds of plastic. The vessel's cockpit shelves were littered with cans and bottles and half a sabacc deck, the remainder of which had fallen down a gap behind one of the dented consoles.

The view outside of the gloomy planetoid Dalastine IV complimented the interior perfectly, thought Thila sourly. Overhead, three pairs of red lights moving in formation sped northward — Skipray blastboats operating from the Rebel base located on Dalastine. Thila slumped in the co-pilot's seat, nursing several canisters of Sullustan ale.

Corwin paused at the door, looked around at the mess, shrugged and went over to the pilot's seat. "I never thought I'd be on one of these on friendly terms," he said, sitting down. "Life takes strange twists sometimes."

Thila allowed the silence to stretch on for a few moments. Then she took a can, opened it and passed a second can to Corwin. After taking a sip, she said, "You wanted to talk to me, Commander Shelvay." It wasn't a question.

"*Arkanian Dawn*. Good name for a ship, that. It triggered a memory." Corwin took a swig of the ale. "How long does it take to get used to a disguise like

that?"

"What?!" Thila paused, taken aback. Then she took a deep breath and released it slowly. "A long time. Years. *Too many years.*" She looked slowly at the mess in the cockpit, and a flicker of a wry smile appeared on her lips. "It's part of me now. I never used to be this untidy."

Corwin smiled gently. "I thought about doing something of the sort," he said, leaning back. "Though, I suppose I did. There can't be more than three people who know the old Corwin Shelvay, and they probably wouldn't recognize me now." He took a drink from the can again, making a pause. "I wonder if anyone remembers Dawn Arkanian."

Thila looked down for a moment, and rubbed her face with her hands. When she looked up, the hard-lined features of a Sullustan slaver were almost gone. Now the resemblance to her brother was more apparent. But Thila also looked careworn and tired.

"I do. But not very well." She gave a dry chuckle, with little humor in it. "I often wondered if naming my ship after my old self was a good idea." Then she fell silent again, as more memories began to return.

Corwin nodded, leaning forward again. "You're safe. I only knew you because of an old friend of mine." Corwin stared into his ale can, his voice trailing off sadly. "A very good friend." After a moment he rubbed his eyes, balanced the can on the console. "That friend of mine was calling himself Dimitri Melamor, and he was my tutor at college. That wasn't his real name. His real name was Darrin Arkanian, which he told me shortly

Matt Talon

Type: Bounty Hunter

DEXTERITY 4D

Blaster 7D, dodge 6D+1

KNOWLEDGE 2D+2

Intimidation 6D

MECHANICAL 2D+2

Repulsorlift operation 4D, space transports 5D, starfighter piloting 4D+2, starship gunnery 4D

PERCEPTION 3D

Investigation 5D+2, search 4D, sneak 4D

STRENGTH 3D+2

Brawling 6D+2

TECHNICAL 2D

Armor repair 4D, demolition 3D, security 4D+1

Character Points: 3

Move: 10

Equipment: SoroSuub QuickSnap 36T blaster carbine (5D damage), BlasTech DY-225 heavy blaster pistol (5D damage), modified Merr-Sonn *Happy Surprise* hold-out blaster (4D damage), 2 vibroblades (STR+3D damage), datapad, macrobinoculars, Aratech Whisper Jumper Jet Pack (carries single passenger 100 meters horizontally/70 meters vertically, fuel capacity for 5 jumps, must cool for one round after each jump, uses *rocket pack operation* or *Mechanical skill*), Scout Armor (+2 pips, does not reduce *Dexterity* attribute or skills)



before he helped me make this.”

Corwin lifted his lightsaber briefly in one hand and looked down at it, silently remembering.

“Yes ... I guessed you were his ... pupil as soon as I heard your full name. I ... had a few letters from him over the years ... Through letter drops and the like.” Thila looked up at Corwin and continued, “He spoke well of you.” There was a catch in her voice as she added, “What happened all those years ago?”

Corwin looked up. She could sense his answer already, he could tell. “We were travelling. I saw a lot on that trip — I was a lot younger ... then. I learned a lot about life, about the realities of the damned Empire. Bespin, Kessel, Tatooine, we even made a stop on Coruscant.”

He looked away, out at the gloomy landscape, and sighed. “We tried to keep quiet, but they found us. I was captured.” He drained the can, then quietly and precisely squashed it.

“They turned me over to Tremayne; Darrin came after me.” Corwin’s face was blank, as though all emotion had retreated below the shell. After a moment he blinked, and expression returned. It was one of grief and sadness and loss. “He told me to run, gave me a name and some cash. I disobeyed him, even fought with Tremayne ... but I wasn’t in time.” He dropped the flattened disc on the console and reached for another can, but didn’t open it. “Tremayne killed him,” he finished quietly.

“Looking back on it, I think he knew how it was going

to go. He marched into it as if he thought he had no choice ... as if he knew he was supposed to save me no matter what it cost him.”

Thila nodded once, with tears brimming in her eyes. “Yes,” she said, simply. Then she gave up the uneven struggle and sat with tears coursing down her face. She seemed in a kind of equilibrium state, not sobbing, but with tears flowing freely.

Corwin sat silently, not moving, with the quiet, sad expression of someone whose tears have all been shed long since. After a while there was the sharp hiss of a can being opened, but no movement to drink.

“I’ve known for a long while, really,” Thila said, in the tight, pain-filled voice of someone crying. “but I needed to be told. Thank you.” She sobbed once. Then she put her head in her hands and started to quake silently.

Corwin put down the can, and moved to put an arm about her shoulders, wondering why he felt nothing beyond regret. Then he felt his master’s presence suddenly, very strongly. He breathed a silent greeting to the shade (real or imagined, he didn’t care). He picked up the ale with his free hand, and sat with the two of them for company, gazing out at the surface of Dalastine.

It was some days later when Corwin saw her again. Or rather, he failed to see Thila. The slaver working for the Rebellion seemed to have fallen away and Dawn Arkanian had finally stepped out of the disguise that she had worn for years. When she saw Corwin, she smiled, and he realized that perhaps he had not been alone in feeling the presence of Darrin Arkanian, Jedi Knight.

you. Eight credits is my final offer. Deal?”). This attitude has earned her the nickname of “The Butcher” among her peers (who are all afraid of her and her bodyguard, bounty hunter Matt Talon).

However, appearances are often deceiving in these days of the Empire. Thila is not a gruesome slaver. In fact, once the slaves are aboard her ship, they learn the truth. The truth of the matter, known to only a few Rebel Alliance operatives, is that virtually all of the holos that Thila sells are extremely clever fakes. Thila uses her shipping network to transport slaves to Rebel safeworlds, where they are freed and recruited into the Rebel Alliance. The profits she makes from the fake



Kaiya Adrimetrum

Type: Rebel Unit Leader
DEXTERITY 3D+2
 Blaster 4D+2, dodge 4D
KNOWLEDGE 3D+2
MECHANICAL 2D+2
PERCEPTION 3D+1
 Bargain 4D+1, command 5D, con 4D+1
STRENGTH 2D+2
 Stamina 3D+2
TECHNICAL 2D
 Computer programming/repair 3D+2, demolition 3D, first aid 3D
Character Points: 8
Move: 10
Equipment: Heavy blaster pistol (5D damage), medpac, comlink, datapad, macrobinoculars, 200 credits



Lt. Davaire Colmar

Type: Reformed Imperial Soldier
DEXTERITY 3D+2
 Blaster 7D+2, dodge 6D+1, grenade 4D, vehicle blasters 5D
KNOWLEDGE 3D
 Survival 4D, tactics: ground assault 5D+1, tactics: squads 5D+2
MECHANICAL 2D+2
 Astrogation 3D, beast riding 4D, repulsorlift operation 5D, sensors 3D, space transports 3D, starship gunnery 3D, starship shields 3D
PERCEPTION 2D+1
 Command 5D, search 4D+2, sneak 4D+2
STRENGTH 3D+1
 Brawling 4D, stamina 4D
TECHNICAL 3D
 First aid 4D, repulsorlift repair 4D, security 3D+1, space transports repair 3D+2
Character Points: 3
Move: 10
Equipment: BlasTech DL-18 pistol (4D damage), hold-out blaster (3D+2 damage), comlink, glow rod

holofeatures are more than enough to keep her solvent, at least for the time being. This “slaver” has saved thousands of people from the wrath of the Empire, and cruel, painful death.

Matt Talon

Matt Talon wears the uniform of the First Sun Mobile (see Chapter Seven, “Military Units”). The uniform consists of light scout-style armor, with the company’s unit insignia on the right shoulder. Talon’s hair is jet black, pulled straight back into a tail. There is a scar that runs from just beneath his right eye to the right corner of his mouth. There is an aura of ill-concealed violence about him, and most of the other slavers tend to steer clear of him. His reputation for his past activities is a great aid with his dealings with other unsavory individuals (“I did this to a xeno on Raskane IV. He squirmed for three days until he died. How long do you reckon you’ll last?”)

Matt Talon was an impoverished young man from an agricultural planet when he joined the First Sun Mobile. The mercenary unit seemed to provide opportunities to improve himself until a sector Moff decided to gain some political ground by taking steps against the First Sun Mobile for its involvement in several atrocities. Consequently, the Moff’s personal stormtrooper guard butchered Talon’s company almost to a man. Matt Talon was one of the lucky dozen or so survivors.

After wandering the galaxy for a few years as a bounty hunter, Talon made contact with the Rebel Alliance and signed on. His Alliance commanders decided that working with Thila on the *Arkanian Dawn* would be a good assignment for him. This has proven to be an extremely accurate assessment. Before Matt Talon met Thila he was on a fast track to the Dark Side. Given his history and the violent streak he possesses, it was simply a question of how long until he turned to evil. However, since he became involved with the Alliance, he has fully realized the evil the Empire represents and is determined to have a hand in its destruction. Talon is fiercely loyal to Thila and would go as far as to interpose his body between her and an incoming blaster bolt or grenade. While he still has a mean and violent streak, he is trying to turn it to productive results.

Kaiya Adrimetrum

Kaiya Adrimetrum is slim and athletic. She has jet-black hair, brown eyes and chiselled, aristocratic features. She is usually dressed in simple technician overalls, and carries a web belt of supplies.

Kaiya Adrimetrum is a widow, her husband killed by the Empire during its occupation of Siluria III. Organizing her friends and relatives

into a revolutionary cell, she led an attack on the Imperial Governor of Siluria III, and was almost immediately recruited by Corwin Shelvay.

Kaiya is young and extremely serious. She *never* understands jokes, and she certainly can't tell them. She is very aware of the responsibilities she carries as a Rebel Unit Commander (even if her unit happens to be poorly trained and equipped). Her troops are doggedly loyal to her, and gaining their loyalty is all the more impressive considering she only just completed her eight week officer training course. A motley and dispirited Rebel unit is a stern test of any commander's mettle, let alone a relatively untried one.

Lt. Davaire Colmar

Colmar is tall, strong, and has a jaw like a block of granite. His close-cropped brown hair is starting to grey and there is a haunted look in his eyes that does not fit with the rest of his appearance. There is a subtle aura of quiet and extreme competence about him.

Lt. Davaire Colmar of the Rebel Alliance is a known deserter from the Imperial Special Training Corps, the fast-track to promotions and glory in the Empire. If the Alliance wins, many Imperial Army officers will face trial for war crimes and Colmar's example will certainly deprive them of the defense that "they were only following orders."

Colmar was in charge of an Imperial army assault trooper unit that was part of a coordinated effort to lay waste to Dalron IV. His unit was engaged in battle when a freak malfunction caused by a Star Destroyer bombardment cut off the unit's communications. A mob of almost 2,000 citizens, wielding captured energy weapons, rallied and attacked. Even an elite army unit cannot last for long against odds of nearly 50 to 1 without backup. The troops only had time to make two calls for help before they were completely overwhelmed; Colmar suffered a head wound.

He escaped and wandered aimlessly for two days, stumbling across the remains of a number of clinically-executed massacres. With his training, it was obvious who had perpetrated the killings. Perhaps this on its own would not have been enough to cause his desertion, since Imperial loyalty is steadfast, particularly for an officer of Colmar's dedication and reputation.

However, a significant part of an officer's training is based on the fact that they are acting to protect the citizens of the galaxy from anarchists and other external threats. While the actions of military units may sometimes seem harsh, their methods are intended to uphold law and order. Colmar could no longer find any way of reconciling this part of his indoctrination with the car-

nage around him. He concluded that the Empire and its agents had failed to follow its own precepts of protecting its own people. This left him with little choice but to desert and join the Rebel Alliance.

Colmar's experience and training have made him a valuable addition to the Alliance. As a ground soldier, he often comes face to face with the units he used to serve in. He has helped the Alliance eliminate several of these units. As he is fond of saying, "They're Imperials. I know *exactly* what they're capable of." He also has extensive knowledge of repulsor vehicle operations since, as an assault trooper, he often served in conjunction with repulsorlift units. Because of this, he can fly just about any speeder in a pinch, and never hesitates to let people know it ("Let's see — the left maneuver vane is shot, the brath bearings are 7 degrees out of true, and the forward repulsor pod is loose. Sure, I can still fly it. Let's go.").

Davar Hamalcal

Davar is a primitive individual who, though dressed in functional work clothes, still tends to look out-of-place. He wears a sleeveless coverall, with plenty of pockets, a supply belt, a cloak, and high, shiny black boots. His long, blond hair surrounds his head like a mane.

Davar Hamalcal was a hunter and scout for his village on Kaellin III, a tiny, backwater world in the Malenstorr system. A skirmish between a Rebel warship and an Imperial supply convoy led to a *Delta*-class Assault Shuttle crashing near his village. The stormtroopers on-board mistook the village elder's peace overture for an attack and

Davar Hamalcal

Type: Curious Explorer

DEXTERITY 2D+1

Brawling parry 4D+1, dodge 6D, melee combat 6D, melee parry 5D+1

KNOWLEDGE 3D+2

Languages 3D, streetwise 5D, survival 6D

MECHANICAL 3D

Beast riding 3D+2, repulsorlift operation 3D+1

PERCEPTION 4D

Hide 7D, search 6D, sneak 6D

STRENGTH 2D

Brawling 5D, stamina 6D

TECHNICAL 3D

First aid 4D

Character Points: 5

Move: 10

Equipment: Merr-Sonn Model 434 DeathHammer blaster pistol (5D+1 damage), SoroSuub Stormtrooper Two blaster rifle (5D+2 damage), vibroaxe (STR+3D damage, max 7D), 6 medpacs



Recruitment Speech

The old mansion house, called “Dovecote” according to the faded wooden sign, was perched on the edge of Koved City, about half an hour from Siluria III’s main spaceport. Most of the neighboring houses were boarded up, abandoned when the Empire moved in. The house’s owner, Kaiya Adrimetrum, sat on a supply crate and looked sadly out across the city, watching the sunrise. There was activity in the house, her daughters preparing food, and patients in the make-shift infirmary moaning from their wounds. And the mysterious figure of Corwin Shelvay moved in and out of the periphery of Kaiya’s awareness.

Kaiya stared out across the garden for a while. Corwin Shelvay went to pick up a couple of mugs from the autochef, and sat down opposite, handing her a drink.

“Good op,” he said mildly.

Kaiya looked up. “Yes. It was.” Her voice was clipped, in control. In her eyes was a memory of the firefight, the smoke, the flying blaster bolts, the *excitement* of blasting those Imperial toy soldiers to hell and gone. Her face hardened. “We didn’t find Governor Quannith’s body, though.”

“The house was coming apart at the seams. Good thing, I guess, or we’d have had more trouble with the Imperials.” Corwin took another sip of tea and removed his hat, brushed dust from the crown. He looked slightly saddened. “We had pretty light casualties considering we faced down two squads of stormtroopers,” he added with a glance at the infirmary room.

“Fourteen injured is *light*?” Kaiya was amazed at this statement. Fourteen injured seemed terribly high to her. Especially fourteen of *her people*.

“Fourteen injured is light,” Corwin affirmed. “Especially against crack Imperial stormtroopers dug in tight in a house. It was the blaster cannon that did it, and Wince with the rifle, I suspect. Open ground would have given us fourteen dead.” He looked down for a while, perhaps at a memory. “Rule number one: never underestimate stormtroopers. They’re only stupid when their commanders are stupid, but give them a straight tactical situation and they become very, very dangerous.” He shook his head, looked up at Kaiya again. “What the hell did Governor Quannith *do* to you anyway?” Corwin couldn’t shake the memory of the evening’s battle, of the ferocity of the quiet woman before him.

“He ... I don’t want to talk about it.” Kaiya looked away, as if suppressing a painful memory.

Corwin wondered briefly what the memory could be, then remembered the house where Kaiya lived. Alone, but with room and personal effects for three or more ... family. Her daughters were here. But no husband.

He looked down, one hand moving to the curious cylinder hanging from his belt. His eyes flicked up to

Kaiya’s face, then he turned his head to look out of the window. He said softly, “Yeah, I know.”

After a couple of seconds, he sighed and shrugged, working a little tension out of his back. Despite the hectic battle, he didn’t seem to be physically tired at all. He looked back at Kaiya. “So what’s your next move?”

Kaiya stopped picking splinters. She looked up at Corwin, her expression hardening again. “We make sure,” she said, “that we finished the job.”

“How long do you plan to spend doing that? The Imperial base on Siluria Three will know about you by now. You have a war on your hands.”

“Not a war, surely. The Empire won’t ...” She stopped short. Perhaps for the first time since Corwin had met her, he could see her thinking hard about all the consequences attending the local Imperial Governor’s death. A few more seconds passed in which time Corwin heard the others moving about in the kitchen of the old house, preparing an evening meal. Seconds stretched to a minute or more before Kaiya looked up.

“We’ll have to become guerillas. We’ll all be hunted.” She paused, her face tightening as further implications sank in. “I haven’t the resources for this. We’ll need more money, more safe houses, equipment, medical supplies ...” She dropped her head into her hands. “These people were my friends. What have I done?”

Corwin watched her a moment.

“My Master once told me about a warrior race,” he said. “They were a careful, considerate people, which was unusual for the type. They had a religion, a belief concerning their commanders. They believed that the commander carried the soul of every warrior under him. It meant that for a man to place himself under a leader was an act of pure selflessness. It also made the officers very devoted to their soldiers. The commander bled with every one of his men and women — he felt them die. But their souls remained with their commander. To the end.” He paused, added gently, “No soldier of theirs ever died in vain.”

“I *conned* them into following me,” Kaiya exploded, angry. “I can see that now.” Kaiya raised her head and glared at Corwin, suddenly suspicious. She hardly knew this man, and somehow she’d let him in on her most audacious scheme. Who is this man, she thought. “What’s your interest, precisely, friend? Are you some sort of galactic crusader? I’m being led in this conversation. *Where?*”

Corwin smiled wryly. “To be honest, yes. I am some sort of galactic crusader. Also, I think we should get you guys off-planet. The Rebellion could use you.”

“You’re *joking!* What would the Rebels want with us? If you *are* a Rebel,” she added quickly, her hand moving slightly toward the cut-down blaster rifle on a nearby

crate. *If he's an informer, he's meat*, she thought darkly.

Corwin shrugged, sensing Kaiya's agitation. "One," he said, enumerating points on his fingers, hoping he could reason with her. "You had enough leadership to gather a group of people. Two, you managed to get enough money together to buy four blaster cannons *and* get them transported. Three, you did this and organized an attack and safe houses without the Imperials knowing. Four, you carried off a successful attack. That makes you very, very good officer material. You've got some good shots and medics on your team, and more people with other skills who can learn more. The Rebellion always needs people like you." Corwin paused, grinning.

"And twenty-five thousand credits of Imperial bounty says that if I'm not a Rebel, I'm doing something seriously wrong." Corwin smiled faintly.

"Twenty-five thousand? Who are you?"

"Twenty-five is the standard bounty for anyone caught with one of these." Corwin unhooked the odd cylinder from his belt and held it out. Kaiya stared at the device without a flicker of recognition. Cautiously, she took it and turned it over in her hand, taking care not to touch any of the control studs.

"What is it?"

Corwin took it back and turned the end outwards with a practiced flick, touching one of the controls. A meter-long beam of brilliant light extended, sending shadows skittering away behind the crates. It made a slight humming noise, louder as he looped the end through a figure of eight so fast that the startling afterimage had not faded by the time it was complete. The number hung there on the retina, slowly fading.

"A lightsaber," Kaiya breathed. "I've heard of them, but never actually seen one. So *you're* a Jedi? I thought you all were supposed to be bearded, wrinkled old men communing with the Force or something." Corwin flicked the saber off, smiling. The humming stopped. Kaiya paused for a breath.

"Not all of us. Look, I can get you in touch with the Alliance, and give you a good reference." He hung the lightsaber back on his belt. "Face it, you can't do much to the Empire here, and you're good enough to make a difference. What do you say?"

Kaiya got up abruptly, and walked back over to the window, rubbing her eyes. "I can't believe this. A Jedi Knight, asking me to work for the Rebellion. And I'm still not sure I can accept." She paused, sighed deeply and turned back to face Corwin. Fatigue was plain in her face. "I had planned to stay on Siluria to fight the Imperials," she continued. "I don't want to leave this place, or my friends. And I don't believe I have to." She fell silent.

"If you stay here, you're hitting at empty air. This place isn't important to the Empire. If you *do* manage to make yourself a serious nuisance, they'll just whistle up a couple of TIE bombers and blow you apart from orbit, and they won't care *who* they kill as long as they finish you." Corwin drained his tea. "The Empire also has a tactic used on worlds it doesn't much need. They start killing the innocent population. It's the oldest anti-guerilla trick in the book: burn someone in the town square at midday every day until they surrender.

"Kaiya, you'll be a good commander, but you'll be wasted here. If you want the Empire off Siluria, you'll have to fight it *off* Siluria. You'll do more damage, and the people here will be safer. And you don't have to leave everyone behind. We'll try and get as many people as want to come out of here. If Siluria needs you, it needs you out there, hitting them where it counts."

"It's that easy, is it? Just fly off, join the Rebellion and all will be well?" Kaiya ran one hand through her hair, distractedly. "I don't think the universe works like that."

"Nothing worth doing is easy. You *will* do more damage to the Empire with the Rebellion, though. You've levelled a Governor's house, Kaiya. Now imagine doing the same thing to a line communications bunker or a reactor house. Not much, but doing it two minutes before a Rebel SpecForce unit hits the base. It can definitely give the Empire a bloody nose. Or worse. Siluria will be safe from any reprisals, too, because they won't know who you are." Corwin stood up, stuck his hands in his pockets.

"It will be rough on you, and all of you who decide to come. I won't lie to you. A lot of people get killed every day. It may be a while before I can find someone to contact, since security's run very tight. But plans are best left flexible: the need is there, the means are there, and you have the talent to make a mark. Trust the Force for the rest."

There was further clattering from the kitchen, and the door opened. A young girl, maybe ten or eleven years old, came in, bearing two steaming plates. "You two have been talking for ages," she smiled. "I thought you'd be hungry."

Kaiya smiled slightly, and took one plate from the girl, her daughter. Then she sat down to eat, facing away from Corwin. It appeared the conversation was over. Corwin looked at her back for a few moments, then took the other plate. "I could eat a Bantha," he said. "Thanks." Then he put his hat back on, and left Kaiya to her thoughts.



killed him in cold blood. Responding to this outrage, the village warriors decimated the stormtroopers in a "glorious battle" (the Rebel Alliance landing party from the orbiting Blockade Runner bailed them out of a hopelessly one-sided battle). Hamalcal stowed away on the Rebel shuttle during the victory celebration. Impressed with his charisma and fighting ability, the Rebels have let him tag along on various missions.

Hamalcal is essentially a primitive barbarian who has been let loose on the galaxy and is loving every minute of it. The high technology often gives him pause, but, he figures, he coped without it on his homeworld, so he can cope without it now; once he has learned how to use the stuff, that will be an added bonus. He also hopes to learn how much money is worth ... eventually ("How much is the red credit worth, again? How much is the blue credit worth? And how much is the yellow one worth? How much is the red one worth again ...") Repeat ad nauseam).

Hamalcal has also learned that while he may not be knowledgeable about technology, he can use this to his advantage. More than once he has succeeded in making people believe that he was over-awed by technology and then turned the situation to his advantage ("Look. Powerful magic. Davar not like magic. Maybe he should smash magic maker ...").

Hamalcal is fond of using his trusty vibroaxe, firmly believing that "blasters have no finesse." He is a boisterous, hard-fighting, jovial man who thrives on violence and conflict, particularly with Imperial stormtroopers, because "they crunch *really* well!"



Mazer Rackus

Type: Brash Pilot
DEXTERITY 3D
 Blaster 4D+1, brawling parry 4D+2, dodge 4D+2
KNOWLEDGE 3D
MECHANICAL 2D+1
 Astrogation 5D, repulsorlift operation 5D, starfighter piloting 6D+2, starship gunnery 5D
PERCEPTION 3D+2
 Con 5D
STRENGTH 3D
TECHNICAL 3D
 Starfighter repair: X-wings 6D
Character Points: 3
Move: 10
Equipment: Merr-Sonn Model 44 Blaster Pistol (4D damage) in a shoulder holster, comlink, macrobinoculars, datapad, hydrosponder, 3 medpacs, Rebel uniform, dark starglasses, X-wing starfighter

Mazer Rackus

Mazer Rackus is a typical-looking Twi'lek, with piercing green eyes, long cranial tentacles and a penchant for spending money. Instead of his species' traditional luxurious robes, however, Rackus usually wears a standard flight suit and his equipment.

Rackus stole his first starship from his father at age 16, and promptly crashed it onto a Rebel-held world. He was captured, but soon convinced the Rebels of his "loyalties," although among friends he admits he was more afraid of facing his father than anything else. He has flown raids for the Alliance ever since.

Loud and brash, Rackus hates to see anything beautiful damaged, demonstrating unusual sensitivity for a Twi'lek. He is very sensitive about his piloting skills and *nothing* ever happens by accident — "That ten degree list to port? That must be, uh... *mechanical problems*. Yeah. That's it..."

Rackus adores speed and risks, at least those that won't cause his ship to crash. He is happy to dogfight TIE fighters, but he steers well clear of Imperial capital ships. It's not that he actually fears death; it's just that they have enough firepower to endanger him, and a run of bad luck could result in another crash. The thought makes him remember his father and cringe ("A squadron of TIE fighters? Great! *Anything's* better than facing my father ...").

Special Operations Teams

The vast majority of recruits for the Rebel Alliance and Empire alike consist of average individuals. These people are assessed and then trained for the roles of soldiers, pilots, administrative staff or whatever other demand needs to be filled. It is a tribute to the Rebel instructors that the Alliance's troops and support personnel are as good as they are.

Unfortunately, this gives rise to an awkward question for Alliance Command and Personnel: "What *do* you do with advanced individuals?" These people can fly starships and repulsorlifts, shoot, trade, gamble, talk the hind legs off a Cracian thumper (or an Alliance commander!), jury-rig things, hack into computer systems, and do just about anything else that can be imagined. Giving them a rifle and sending them out with the line troops is a waste. Assigning them an X-wing only uses half their skills. Where can they *possibly* be given work that uses their skills more efficiently?

The answer is Special Operations: the panacea for beleaguered Personnel officers. Special Ops is a perfect location for advanced, highly skilled individuals who don't fit the role of a

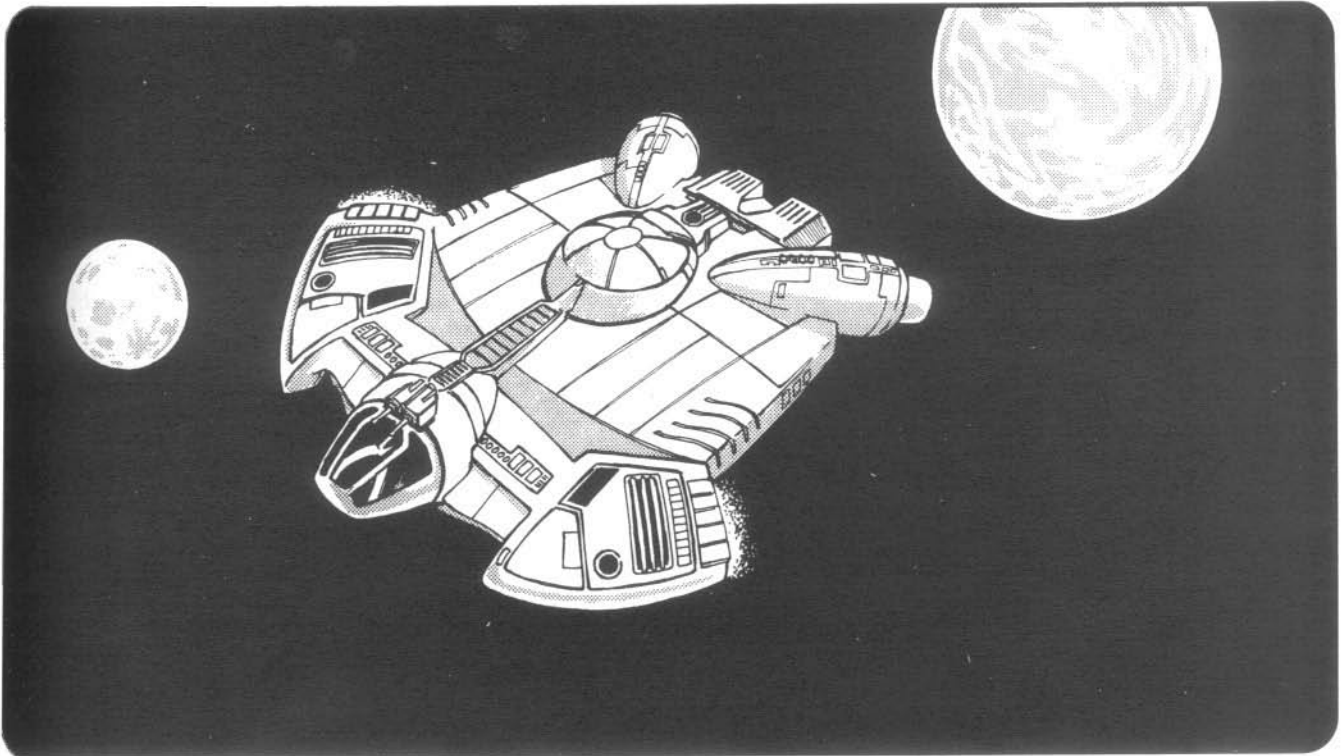

standard soldier. Special Ops troops are known for their flamboyant actions and the ability to succeed where only sheer luck and the favor of fate could have allowed survival. Special Ops as a concept has two levels of operation: beginning Special Ops units are called Mission Groups; experienced units, who are generally given more difficult missions, are called Special Ops Teams.

Listening to a Special Ops operative talk is like hearing an old spacer weave stories about 50 kilometer long space slugs. You never know where the truth ends and the fiction begins.

"You need 100,000 credits by two weeks ago? No problem."

"The sector Moff needs his ytterbium stolen? Well, they didn't have time to unload it, so they stole his landing barge as well ..."

"You want us to blow up a what? Is that all? It's guarded by a company of stormtroopers? Oh, right. We'll be careful ... yeah, *sure* I know what careful means ... Do you want us to do any shopping while we're there?"

Mission Groups

Most groups of player characters involved in the Rebel Alliance will be assigned to a Special Ops Mission Group. This allows the Alliance to make full use of these individuals' "exceptional" skills, while not restricting them to the duties of traditional spec forces organizations. Mission

Note To Gamemasters

"Is my group good enough for Special Ops?" As a general rule, if you need to ask this, the answer is "no."

If your group is good enough, you'll *know* they are. They'll have a habit of succeeding in their scenarios with ridiculous ease, perhaps even to the extent of inventing other mission-scale objectives of their own as space-fillers. This will be particularly true for published scenarios, which are usually written for average characters for obvious reasons.

Good Mission Groups have been known to do the impossible; present a group of Special Ops caliber characters with the same challenge, and they'll say "That's too easy," come up with an *even harder* objective of their own, and do that *as well*. Be warned; it isn't really the skill levels of the characters that makes a group suitable for Special Ops Team status — it's the players.

The very best players can cause the Imperials more trouble with a bunch of starting characters and one Force Point apiece than most groups could manage playing Han, Luke, Leia and Chewie, and with Force Points to match. Only the first type of players are suitable for Special Ops Teams.

Groups fit into the Alliance chain of command as "floaters" between Alliance command, standard forces and sector forces. They can be sent out on loan to sector forces desperately in need of support, but often end up travelling half-way across the galaxy in the course of their exploits.

It also means that all that free-floating cocki-

ness is put to constructive use, rather than into driving base commanders and security personnel crazy. As a result, the Alliance has a broad base of talented units who are willing to take a crack at any mission anywhere in the galaxy.

Many Mission Groups are based at Rebel starfighter bases like Tierfon, Cathis, Ansarra or Dalastine. This means that they have somewhere to refuel and resupply their ships without harassment. Most teams have their own transport, often a light freighter of some sort, and in addition the starfighter base can make use of the high piloting skills often present within such a group.

This is a better set-up than even Alliance Intelligence (Intell) can provide; most Rebel intelligence operations are designed to be covert, which means that the operatives can be in place for a long time before doing anything. Mission Groups thrive on action; in the Intell environment, they'd have blown covers inside a fortnight, and would end up making a spectacular escape off-planet, wrecking months or years of painstaking Intell groundwork as they went. True, they probably would escape, but this is of little benefit to the Intelligence department.

Of course, Mission Groups are often sent to worlds to draw attention *away* from an Intell cell that is about to be discovered.

Operating from a starfighter base isn't the only arrangement, of course; some Mission Groups are used as roving agents, and are transferred from one area to another as problems crop up, while others are used in the Intelligence Operations department (notwithstanding the comments above), in Ordnance and Supply, and even in Support Services. SpecForces also occasionally takes a Mission Group under its wing, usually as "other specialists" such as transportation specs, pilots, communications experts, translators, medics, scroungers and the like. These areas are more fully detailed on page 40 of the *Rebel Alliance Sourcebook*.

Using Special Operations Teams

For frustrated gamemasters who have always wanted to know how to integrate player characters into the structure of the Rebel Alliance, Special Ops Mission Groups are the perfect route. Depending upon the situation, Mission Groups can be called on to do just about anything, at any time, for any reason.

These teams combine maximum freedom (always a plus for notoriously independent players) with a way of helping the characters get involved in the heart of the struggle against the Empire.

Special Ops Teams

"Special Ops Teams are where Mission Group members go when they have become '23ers' but are still too young or energetic for a desk job."

— Adison Cray, Free Agent

"I'm too old for a desk job, it appears, so I have to carom around the galaxy like a maladjusted space skeet, too. I have always suspected that I won't be able to retire on health grounds until I've been dead for at least two years, such is the Alliance's need for skilled personnel. Many special operatives are doubtless in the same position. It's not just a job ..."

— Jakob Biddyn, Special Operations Group Leader

Special Ops Teams are "advanced Mission Groups" and are cut off from the Alliance command structure. They are answerable to only a few higher-ups, and receive practically no backup whatsoever from any branch of the Alliance. They receive no support from Ordnance and Supply, no X-wing or SpecForces support, nothing. They just don't *need* this kind of "mollycoddling."

The difference between Special Ops Teams and Mission Groups? Mission Groups get orders; Special Ops get *requests*. Polite requests. If they wouldn't mind, if they're not too busy, please. And if the Special Op says no, that's just too bad. Most of the time, "spooks" go looking for their own trouble.

Some Special Ops go on deep-cover missions, using a number of Rebel supply caches to keep running. Alternatively, they might set up a network of these caches themselves, possibly as the nucleus for rebellion in a new sector. This often involves a fair amount of trading, then plunging the profits of the trade into the supply caches. Other Special Ops may be free agents, and simply roam the galaxy looking for things that need doing. After all, the security network at the Imperial Shipyards around Seswenna was *woefully lacking* ...

Where necessary, the Alliance does have means of contacting Special Ops Teams in the field, via contacts, mail drops, personal ads and the like. If a sector intelligence cell or Rebel outpost has need of the talents of a Special Ops unit, it can put a call out through one of these channels, and any spook in the area can then pick up the message and arrange to meet at a neutral venue. But by and large, these units are left to wreak havoc upon the Imperial war machine without the Alliance watching; an arrangement that suits all sides admirably (except for the hapless Imperials).

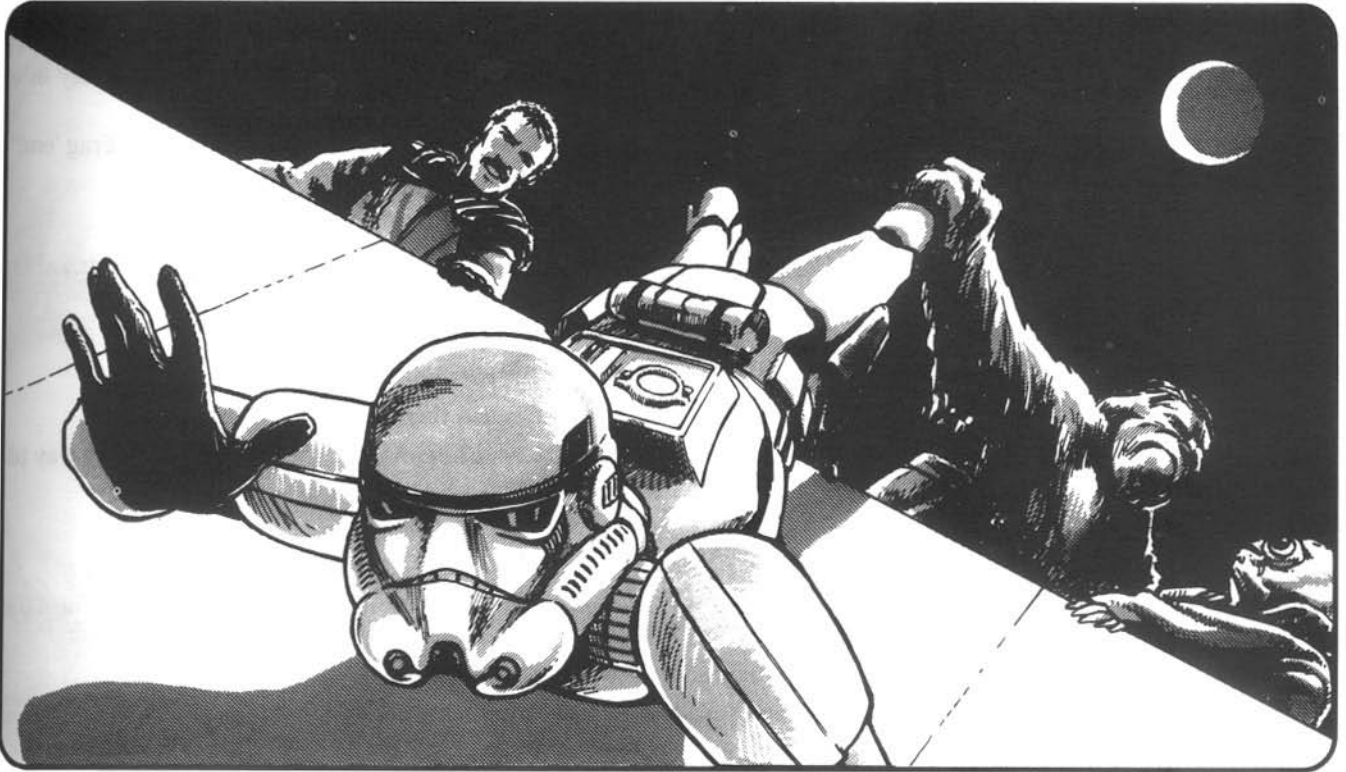

Special Operations Slang

Special Ops Teams take a lot of trouble to ensure that their jargon is at least twice as obscure as anyone else's.

Some Special Ops Teams also like to engage in conversations with members of other branches of the Alliance in order to see just how long they can get away with talking at cross purposes. Special Ops *especially* enjoy confusing the stuffing out of Alliance Intell operatives, who have their own slang (see page 26 of the *Rebel Alliance Sourcebook*), although most Special Ops Teams have figured out all of *their* phrases. With a Special Operative around, conversations seem to get just plain *weird*: phrases like "5-G takeoff," "cuddly toy," "take a gander" and "she's cute" have completely different meanings.

The following list is already somewhat out of date, as Special Ops Team slang is constantly revised to ensure that no one else is ever in danger of understanding what Special Ops personnel are talking about.

#Chicken Alarm: A hazard assessment, follows an exponential sequence: 1, 2, 3, 5, 8, and 13. Chicken Alarms have been known. 13 is a Death Star sighting, 8 is a fleet arriving in-system, 5 is a solitary Star Destroyer, 3 is a ground army, 2 is a small fleet, 1 is any other sizeable operation. This term is also used to rate the relative danger of a mission.

#G's: (7G's, 8G's) Number of hostile aliens.

23er: In Alliance Intelligence, an agent who has made 20 field assignments and been retired; in Special Ops, any very competent agent.

ABH: Average Bounty Hunter, or rather, *above-average* bounty hunter.

Acquisition Run: Any combat operation presenting opportunities for large-scale theft.

Battery: A lot of chickens huddled together, enough to make even a Special Op *slightly* nervous.

BBH: Boring Bounty Hunter, the common run of target practice.

Bear: Balinaka.

BH: Bounty hunter.

Birdwatcher: ISB Agent, from "Imperial Sunbathers and Birdwatchers" (Special Ops crew tend to have a low opinion of the ISB).

Black: Any large denomination (1,000 credits +) that is probably "blackmarked" and traceable.

Boring: Either "extremely dangerous" or "no threat at all" or possibly both at the same time. Only Special Ops know how this one works.

Boys in White: Stormtrooper.

Brass Mine: A Special Operative.

BUG: (Big Ugly Guy) Any hostile alien.

Bursting: *Physical:* Dealing with a large predator by waiting until it opens its mouth and then feeding it a live grenade or thermal detonator. *Conceptual:* Entering a known enemy trap with much more firepower than the trap can handle, or using an enemy's offensive action as an opportunity to do him harm.

Can't: Tank (deliberate misspelling).

Cat: Orryxian (Not that any Orryxian would appreciate this).

Catnot: (Contraction of "Categorically Not") Refers to Kashyyyk, the Wookiee homeworld.

CB: Cybernetic Bronchitis. Nickname for Darth Vader.

Chicken: Any Imperial operation or personnel.

Chorus Girl: Imperial AT-ST Walker.

Coop: A lot of chickens huddled together.

Cuddly: Incredibly Dangerous.

Cute: Extremely Dangerous.

Defenestrate: Throw person out of window.

Delimit: A Wookiee attacking in hand-to-hand combat. Any hand-to-hand combat attack by a very strong opponent. This word is believed to be a corruption of "De-limb it."

Difficult: Easy.

Dobbin: Imperial AT-AT walker.

Doesn't: A Wookiee.

Don't: *Plural*, several Wookiees.

Drink Vouchers: Money.

Duck: Any undercover Imperial operative that is trying not to look like an undercover Imperial operative.

Dumb Orphan: Orphan with valuable information.

Easy: Difficult.

Easy Easy: Easy.

Entertainment: Combat.

ETLA: Extended Three Letter Acronym. A Four Letter Acronym. *See* TLA.

Fatigue Scanning: Looking for the weak spots in a system or organization.

Fear Gland: Self preservation instinct. Considered a bad quality in Special Ops.

Firework: Anything containing a reasonably large fusion reactor.

Fish: Fish.

Fish: Mon Calamari (or any other aquatic species).

Fish: Trouble (obviously, depends on context).

Frac: Fraction of a credit, particularly any non-Imperial currency unit.

Frac's'n'Blacks: Large quantity of money in all denominations.

Frag: Fragmentation grenade, as in "Frag 'em!"

Gander: Grenade.

Gark: Any flying species.

GBH: Gross Bounty Hunter, i.e. Boba Fett, Zardra, Dengar, IG-88, etc.

Gnu: Gun, slugthrower.

Grease: Funding for bribes.

Grease the Servos: Funding for bribes.

Greenhorn: A new Rebel soldier who's way too eager for combat.

Greenie: Rodian.

Grey Man: Imperial Intelligence Agent.

Gronk: Any species capable of generating a particularly loud cry/alarm call. As in "Gronk!"

Gruff: Any canine-appearing species.

GS (Groundshaker): Imperial AT-AT Walker.

GUB: Great Uncle Boba, refers to Boba Fett.

Hammerheads: Ithorians.

Headhunting: Physically locating an enemy's "head" or main nerve center with a view to destroying it.

Headshot: Any single operation that renders the rest of an enemy's operations useless.

Hijack: Con, bribe, trick, order or otherwise persuade a complete stranger to render assistance in some task.

Hitching a Ride: Using someone else's intelligence network or facilities, usually without their knowledge or permission.

HSS: (High Speed Surgery) Disabling an armored vehicle or starship by cutting a hole in its hull and injecting a grenade or thermal detonator into the gap.

Hundred Club: Those individuals whose bounties exceed 100,000 credits and are still at large.

Interesting: Very Dangerous.

Invite: Explosive device.

Jack: Anyone, as in "Hi, Jack," said to a complete stranger.

KSA: Kinky Silver Armor. An Imperial Radtrooper.

Leech: A spook with 'acquisitions' skills (*security*, etc.).

Less Boring: Dead. *See* Boring.

Lightly Tronned: A tron where the vehicle crew survives. *See* Tron.



Livestock: Assorted weapons, explosives and heavy artillery.

Mildly: (*Adjective*) Extremely.

Million Shot: A “very easy” mission. “It’s a million to one chance, but it might just work.”

Mindspook: A spook with Force skills.

NRU: Nice Red Uniform, an Imperial Royal Guardsman.

One Percenter: Mission carrying a 1% survival chance. A “standard” mission.

Orphan: Rebel soldier or pilot stranded in the field.

Penned Orphan: Orphan captured by Empire.

Planters: Ithorians.

Plastic Soldier: Stormtrooper.

Portable: Anything a Special Op finds necessary to remove. Even if the item in question weighs 60 tons and has been molecularly welded to the ground, if a Special Op needs it, it will be removed.

PSC (Plastic Soldier Carrier): Imperial AT-AT walker.

Raisin-head: A greenhorn who’s seen too many war holos.

Red Carpet: Large quantity of explosive devices.

Salting the Ether: Generating spurious plans for

non-existent missions and broadcasting them in tight code in spare bandwidths to keep Imperial Intelligence’s Analysis Bureau from getting bored.

Sandman: Imperial sandtrooper.

Scoping: Estimating resources needed for an operation. Or, maintaining surveillance on members of the opposite sex (Depends on context).

Scrip: Corporate or Planetary currency.

Season Ticket: Several explosive devices.

Severely Tronned: Where practically nothing survives. *See* Tron.

SideThink: Peculiar Special Ops mindset, blending opportunism, careful planning and lethal efficiency with a healthy dose of mindless recklessness and pure cockiness.

Slimebottom: Hutt.

Slug: Hutt.

Smart Orphan: Orphan without any particularly valuable information.

Snowman: Imperial snowtrooper.

Spook: A Special Operative, particularly a solo one.

Squawker: Any flying species.

Squid: Quarren.

Squid Head: Quarren.

SS: (Skywalker Surprise) Mission carrying a 0.1% survival chance. An “interesting challenge.”

Star Destroyer: 174,000 design flaws waiting to be exploited.

Sweet: Cute and cuddly.

TAD: A thermal detonator. As in, “Add a TAD to fix that Imperial squad.”

Takeoff: Eliminating prime weapons, while leaving the heart of an objective intact. For example, destroying defensive ion cannon while leaving a power plant intact, or downing the bodyguards of a powerful but unarmed crimelord.

TAM: Threatening Armored Man. An Imperial Storm Commando.

Ten Percenter: Mission carrying a 10% survival chance. An “easy” mission.

TEPM: (Thermal Exhaust Port Mission) Mission carrying a 0.1% survival chance; an “interesting challenge.”

Thinking Sideways: A compliment.

Thousand Shot: Mission carrying a 0.1% survival chance. An “interesting challenge.”

Tinfish: Imperial seatrooper.

Tinfish Bucket: Imperial AT-AT Swimmer.

TLA: Three Letter Acronym.

Toy: Melee or heavy weapon.

Trawling: Out looking for “fish” (see “fish”).

Tron: Cause opposing vehicle to suffer a “spectacularly debilitating irreversible maneuvering capability deficit,” or crash. “That’s troned it.”

UCT: (Universal Cutting Tool) A Lightsaber.

Vapor Op: A hopeless plan, of the type produced by greenhorns, laser-brains and raisin-heads.

Very Dumb Orphan: Orphan who “knows too much” and must either be rescued, silenced or discredited in some way.

Wake-up call: Grenade.

Won’t: A town or a Wookiee village, believed to derive from a deliberate misspelling of “town.”

Wotshisname: Practically anything or anyone, mainly depending on context. As in “Tell wotshisname to get up here with that grenade!”

Wolf: Shistavanen Wolfman.

Yellow Stuff: Stabilized ytterbium.

The Most Dangerous Positions In The Rebel Alliance

The Rebel Alliance is full of dangerous jobs: fighter pilot, SpecForce operative, Wookiee hand-to-hand combat tutor, autochef operator and so

on. However, some jobs are considered particularly dangerous, even by Rebels with no “fear glands.” Some of these positions are outlined below.

Special Ops Teams

Special Ops Teams consists of people who go out into the galaxy, find some trouble, get themselves as deep into it as they possibly can, and then get out again. Special Ops Teams are so good that trouble that would be fatal to most other people seems to them to be all part of a day’s work and they *do* get to choose how deep in the dip they go. Chicken factor: 5 or more per mission.

Mission Groups

Most of what applies to Special Ops applies to a lesser extent to Mission Groups. The main difference is that as the Alliance chooses their missions, Imperial traps or poor estimates of the level of opposition may mean they occasionally get in over their heads. Chicken factor: 2 to 3 (theoretically; more likely 5 or more per mission).

Field Agent

Field Agents are given specific objectives (short or long term) by the Intelligence Operations Department. They go out, perform these tasks and then return. After twenty such missions, they must either retire or transfer to another department. See page 27 of the *Rebel Alliance Sourcebook* for further details. Chicken factor: 1 to 3 per mission.

Free Agent

Becoming a Free Agent requires special dispensation from Alliance High Command. A Free Agent is essentially a solo Special Operative. There does appear to be a subtle distinction between the two of these, as solo Special Ops are also known, but the two posts are basically the same. The most likely difference is that a Free Agent *does* report to the Intelligence department, either to the head of Operations, or to the Chief of Intelligence himself. No Free Agent is anything *less* than a full 23er. Chicken factor: 8 or more per mission.

Special Agent

The post of Special Agent is a catch-all category and is used to describe the unique posts filled by certain individuals. For example, Greg Somax, the one Rebel agent at the Imperial Naval Academy (see page 141 of the *Rebel Alliance Sourcebook*) is a Special Agent. Chicken Factor: 3 or more per mission.

Recruitment Agent

This is one of the most dangerous jobs in the Alliance. Recruitment Agents are people who are constantly on the lookout for new membership for

the Rebel Alliance despite the fact that any one of the people they approach could be an Imperial plant, a collaborator or an informant. And even if they are not Imperial agents, there is *still* a risk that the prospective recruits are staunch enough citizens (despite their anti-Imperial opinions), or desperate enough for the 10,000 credit reward that is in place on certain planets, to turn the Agent in to the Imperials.

There are only two things that stop more Recruitment Agents being compromised. One is the sheer number of people who are genuinely opposed to the Empire. The second is the fact that the Empire may choose not to haul the Agent in so that they can use him to feed spies into the Rebel Alliance. This second option can (and has) had *catastrophic* consequences for several Rebel outposts. Even the best Recruitment Agents can expect to make a bad call about once every three to five years. More often than not, the Agent's first bad call is also his last. Chicken factor: 7 or more.

Supply Agent

Supply Agents are people who go out looking for material to buy for the Rebel Alliance, despite the strict export controls that this material invariably carries. It is relatively easy for an Imperial Auditor to notice that quantities of sensitive, high-tech materials are being bought by such and such a company, and decide to investigate, and there are limits to how far a Supply Agent can go to disguise his activities. Agents, once discovered, are often arrested and taken for interrogation, although Imperial Intelligence has tried insinuating S-Thread Trackers into the cargo consignments to see if it can trace the location of the Rebel supply bases. This technique has not proved very successful because Rebel outposts are in such out-of-the-way places that the trackers have only been able to narrow the location down to the nearest ten parsecs or so. Overall chicken factor: 3 or more per mission.

Observer

A moderately dangerous post, although it does depend on what is being observed. Observers who are caught generally get about the same treatment as Supply Agents. The danger of the Imperials using a compromised Observer post to supply false information to the Alliance is a very real one; the consequences can be dire. Chicken factor: 3 or more depending on the subject under observation.

Foster Agent

Foster Agent is hands-down the most dangerous of all jobs in the Rebel Alliance, with a guaranteed chicken factor of 11. Kina Margath, of "Margath's in Elshandruu Pica," is a Rebel Foster Agent. Her mission, as is the mission of every Foster Agent, is to collect orphaned agents and return them to the Alliance. Rebel X-wing pilots, for instance, are given the name of a Foster Agent, so that if they have to bail out they have a ground-based contact who can make arrangements to get them back to the Alliance. Mission Groups operate under the same arrangement in case they miss their pickup rendezvous, lose their ship or some such. This is at *least* as dangerous as the activities of other Rebel agents, with the added problem that if the Imperials capture a pilot, they may be able to break him or even re-program him as a double agent before letting him go on to the Foster Agent. All judgment calls in this case are at the absolute discretion of the Foster Agent.

This is a much higher risk than any other Rebel has to undergo; the Foster Agent is dependent on his *orphans* not being captured or broken. For all other Agents, it is the Agent himself who suffers this fate, but a Foster Agent can face the worst consequences of Imperial interrogation through absolutely no fault of his own — and with no chance to reduce the risk of it happening.

Chapter Two

Imperials

The upper command levels of the Empire provide interesting and dynamic villains for player characters in the Outer Rim Territories. These characters would be suitable villains for a long-running campaign, and whose minions could continually plague the actions of the player characters.

High Inquisitor Tremayne

Very little is known of High Inquisitor Tremayne's past, save that he once trained as a Jedi Knight before being seduced to the Dark Side of the Force by the Emperor. It is rumored that Tremayne has trained to be a type of specialized operative of the Emperor's will, an "Emperor's Hand," but these rumors have never been substantiated and prudent beings avoid asking the Inquisitor about it.

Imperial Intelligence (Intell) has long proven adept at wresting information from even the most recalcitrant of prisoners. It has many sophisticated devices of torture at its disposal, including pain tables, nerve inductors, selective neurotoxins, sensory deprivation chambers, sensory overload chambers, truth drugs and IT-series interrogation droids, all of which prove frighteningly effective at breaking subjects both mentally and physically.

There are, however, two cases where the technology of Imperial Interrogation either has no effect or cannot work fast enough for time-critical information to be extracted before it is rendered out of date. The first case is in those very rare incidents where a Jedi has been captured. These individuals are invariably unaffected by the Interrogation Unit's ministrations and can even will themselves to die to avoid giving any information. The second case is where a subject proves to be far more naturally resistant (or extremely well-trained) than anticipated. In the cases where the standard technology is ineffective, the Empire has another avenue: it brings in an Inquisitor.

The Empire's High Inquisitors serve directly under the Grand Inquisitor, and Tremayne is the most feared and respected of the High Inquisi-

tors in the Outer Rim Territories. Tremayne has formidable interrogation skills, and also has Force skills to provide additional leverage. He is a master of manipulation and his mere presence is sometimes enough to break the will of those who have resisted all other approaches. He is quiet and calm in reassuring his victims that they *will* break ("The procedure is regrettably, *quite* painful, I assure you. Wouldn't you rather talk to me now?"). Tremayne has failed to break only one victim: Corwin Shelvay.

Imperial Intelligence is so good at breaking victims that the special talents of an Inquisitor are needed only on rare occasions. As a result, Tremayne spends a lot of his time scouring the galaxy, looking for any individuals with Force abilities or Force sensitivity. On encountering a new prospect, his prime objective will be to convert him or her to the Dark Side of the Force (a mission he often succeeds at); failing that, the victim is killed. The Imperial II Star Destroyer *Interrogator* is at his disposal at all times, and he has a free hand to go where he wishes and act as he sees fit. He is answerable only to the Emperor, Lord Darth Vader, the highest echelons of the Inquisitorius and the most respected of the Emperor's advisors.

Inquisitor Tremayne is a tall, slender Human, who wears black robes at all times. The right side of his face and his right arm have cybernetic replacement parts, the result of losing a lightsaber duel with Corwin Shelvay some years ago. Rather than hunt Shelvay out, Tremayne is content to wait in the knowledge that the power of the Dark Side will allow him to triumph when next they meet. Tremayne has deliberately chosen metal-pattern cybernetics for the replacements to enhance the fear that his presence induces in those he interrogates (not to mention the fear he provokes in his *subordinates*). He is faultlessly polite, cultured, and calm, which also serves to unnerve his subjects ("And now, my Rebel friend, we shall have a ... chat.").



■ High Inquisitor Tremayne

Type: Imperial High Inquisitor

DEXTERITY 3D+2

Blaster 4D, dodge 6D+2, lightsaber 7D+1, melee combat 6D+2

KNOWLEDGE 4D

Bureaucracy 6D+2, cultures 6D, intimidation: interrogation 7D+1, intimidation: torture 7D+2, planetary systems 5D+2, tactics: fleets 5D+2

MECHANICAL 2D+1

PERCEPTION 3D+1

Command 6D+2, con 5D+2, investigation 7D+1, search 5D

STRENGTH 2D+2

Brawling 4D, stamina 6D+2

TECHNICAL 2D

Special Abilities:

Force Skills: Control 4D, sense 4D, alter 5D

Control: Absorb/dissipate energy, accelerate healing, control pain, hibernation trance, reduce injury, resist stun

Sense: Combat sense, danger sense, life detection, life sense, magnify senses, receptive telepathy, sense Force

Alter: Injure/kill

Control and Alter: Inflict pain

Control and Sense: Farseeing, lightsaber combat, projec-

tive telepathy

Control, Sense and Alter: Affect mind, telekinetic kill

This character is Force-sensitive.

Force Points: 7

Dark Side Points: 12

Character Points: 15

Move: 10

Equipment: Lightsaber (5D damage), black robes, datapad, blaster pistol (4D damage), comlink

Ahnjai Rahmma

Ahnjai Rahmma is the private bodyguard of High Inquisitor Tremayne. A member of the felinoid Srrors'tok species, Ahnjai is bipedal, with a short, golden pelt. He wears only a body pouch containing various general purpose tools.

His muscular build makes him quite intimidating; his sharp fangs and ferocious appearance are those of a born hunter and predator. Because of his jaw structure, speaking Basic is very difficult for him. However, if he speaks slowly, he can produce simple words (his species' native language, Hras'kkk'rarr, is a very sophisticated combination of growls, snarls and other sounds that are easy for his species to make). Often, a slow growl with a mumbled, "Kneel ... now," and a flexing of his taut muscles is more than enough to bring a potential combatant to his knees.

He generally prefers to remain silent, answering Tremayne only when necessary ("As ... you ... (growl) ... wish, Lord."). His species uses a combination of body language and gestures for communication, but he refuses to use this form of communication as an expression of his involuntary servitude to Tremayne.

The Srrors'tok have an honor-based societal structure (in many ways similar to the Wookiee social structure, including the so-called "life debt"). Tremayne, in a series of events that the Srrors'tok has refused to elaborate on, has somehow earned the life debt of Ahnjai. He must now serve Tremayne, and through Tremayne, serve the Empire. It is a matter of honor that he discharges this debt to the best of his abilities, despite his distaste for the immorality of Tremayne and the Empire's actions. According to Srrors'tok law, Ahnjai must completely fulfill that debt or take his own life.

Tremayne takes full advantage of Ahnjai's service. Aside from bodyguard duties, Ahnjai is sometimes required to commit assassinations and murders on the Inquisitor's behalf. Tremayne also publicly treats Ahnjai like a pet, "affectionately" taunting him in front of other Imperial officials. Ahnjai would dearly love to be freed from the life debt so that he could kill Tremayne for these humiliations.

Ahnjai has two possible means of escape: one is to die serving the Empire. The other is if he found himself in life debt to an enemy of the



Empire — whereupon he could count both debts as discharged. In this case, and depending on how it arose, he might even choose to be bound by the second life debt. It is a matter of honor, and thus life itself, that he doesn't deliberately put himself in a situation where a second, conflicting life debt could arise. Ahnjai Rahmma is likely to remain an extremely dangerous enemy.

■ **Ahnjai Rahmma**

Type: Srrors'tok Warrior

DEXTERITY 4D

Blaster 5D, brawlng parry 6D, dodge 6D, melee combat 5D+1, melee parry 5D

KNOWLEDGE 2D+2

Survival 5D

MECHANICAL 2D+2

PERCEPTION 3D

Hide 6D+1, search 6D+1, sneak 6D+1

STRENGTH 3D+2

Brawling 5D, climbing/jumping 6D

TECHNICAL 2D

Special Abilities:

Voice Box: Srrors'tok find it very difficult to pronounce Basic. Have a complex language of growls and snarls.

Sign Language: Srrors'tok have very complex sign-language and body language.

Teeth: STR+1D damage.

Force Points: 2

Dark Side Points: 2

Character Points: 8

Move: 13

Equipment: Body pouch, toolkit, Imperial ID, 100 credits

Moff Abran Balfour

Abran Balfour is a mousy-haired individual with close-set eyes and a perpetual "five o'clock shadow." He is of average height and has the beginnings of a pot belly. He *certainly* doesn't look like anyone's idea of a "fearsome" Imperial Moff, and because of his utter lack of charisma or political savvy, he has been relegated to "controlling" Parmic Sector.

Balfour is a quiet individual with an academic bent. He has a good knowledge of galactic history, and believes himself to be an astute, though unobtrusive, politician. Everyone else considers him an incompetent fool.

His biggest problem is his total inability to gain the respect of military personnel under his command, and their respect is something he would need if ever any serious opposition to Imperial rule arose in his sector.

At present, things are quiet, and Balfour is generally content to allow things to run themselves: As he is fond of saying, "Rebel activity? In my sector? Ignore it and it will go away." He busies himself with his consuming interest, the operation of an old Thalassian luxury space barge called the *Lady Telura*. This is a vintage "collector's item" spacecraft, and requires a lot of attention and many expensive, difficult-to-obtain spare parts to keep running. As a result, Balfour is often

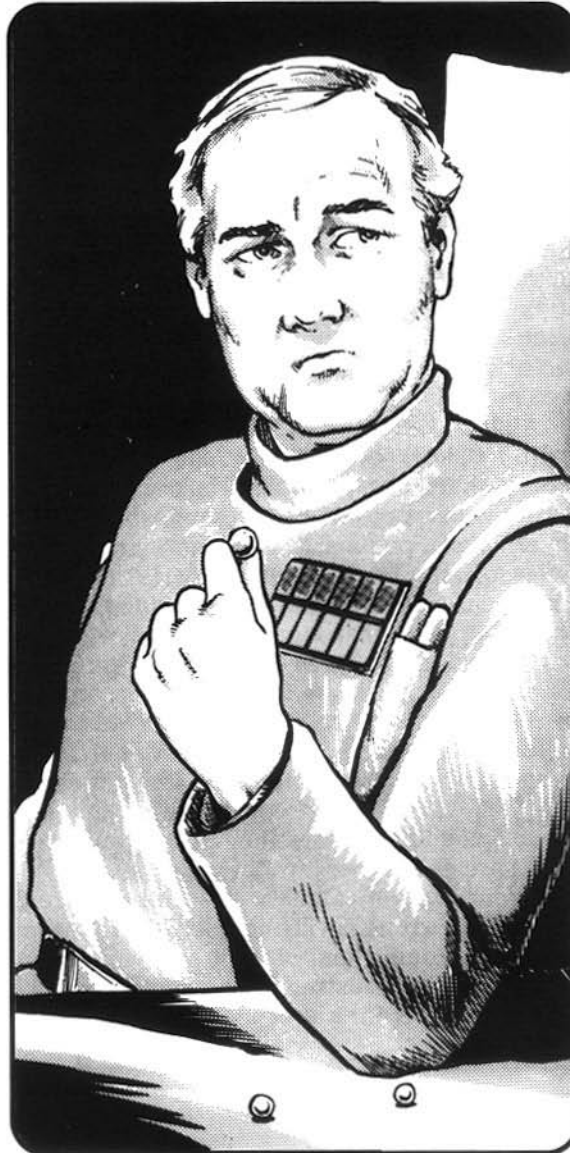

away from his sector capital trying to find the spare parts he needs to keep this vessel running.

Being a Moff, he is able to requisition a faster vessel should he need to return to Parmic Sector. His sensitive political antennae *usually* give him sufficient warning if any serious problems arise. Of course, having to interrupt this relaxing life and actually apply himself properly to his job would be likely to make him rather petulant.

Balfour has not needed to do a great deal of governing of this sector, at least in his estimation. By and large, the planetary governors are left to their own devices. There are a few hot spots in the sector (Laramus, notably), but generally speaking, leaving these areas alone has let them smoulder on without doing any great harm (a clamp-down might well cause resentment to flare up into something far more serious).

Because the final stop on the Llanic Spice Run is in Balfour's sector, at Spice Terminus, Balfour has a good selection of military hardware at his disposal: a full Sector Group. The Sector Group spends most of its time patrolling the route of the Spice Run, but also sends regular patrols to Laramus and the other sector hot spots. The sector army units are all well-equipped, and most units have been augmented to some degree. The Rebel Alliance has not performed full-scale operations in this sector, and in fact the route of the Spice Run, which seems to be the only part of the sector of any great importance, is so well-covered by the Imperials that any action would cost the Alliance more than it would gain.

Moff Balfour doesn't have any enemies as such; just neighboring Moffs who are more than a little concerned about his hands-off style of government. Foremost among his critics are Moff Pelles of the Torch Nebula, Moff Ammar of Portmoak Sector and Moff Sakai of Thuris Sector. Ammar in particular is concerned because he has had extensive Rebel activity on most of the major planets in his own small sector, and he suspects that the perpetrators are based in Balfour's territory. He's wrong; Cor'ric and Quence Sectors are the home bases of the culprits. Pelles and Sakai are concerned because the Llanic Spice Run crosses their sector, and they would prefer a higher level of security.

Balfour feels that his sector is completely secure. He is wrong. It will smoulder on for months or years to come, then, with the right spark — a general driven to distraction by continued lawlessness, a governor's incompetence, a carefully-

planned Rebel strike, or rumors of a mothballed Mandalorian battle cruiser drifting *somewhere* in Balfour's territory — there will be a scramble of Imperial activity and Parmic Sector will attain high-classification "danger zone" status virtually overnight, along with everything that that status implies.

■ Moff Abran Balfour

Type: Academic Imperial Moff

DEXTERITY 2D+1

Blaster 3D+2, dodge 5D

KNOWLEDGE 4D

Alien species 5D+1, bureaucracy 6D, law enforcement 6D+2, planetary systems 5D+2, scholar: history 7D

MECHANICAL 4D

Archaic starship piloting 7D, astrogation 6D+1, space transports 5D+2

PERCEPTION 2D+1

Command 3D

STRENGTH 2D

TECHNICAL 3D+1

Archaic starship repair 6D, space transports repair 6D

Character Points: 5

Move: 9

Equipment: Blaster pistol (4D+1 damage), Imperial Sector Moff uniform, datapad, Imperial ID, 1,000 credits

Elena Shelvay

Elena Shelvay has shoulder length blonde hair, blue-eyes, and a slim, athletic build. She usually wears functional clothes, but on her, the results range from alluring to stunning.

Elena Shelvay is Jedi Corwin Shelvay's younger sister. Elena has a naked contempt for her older sibling as a result of the "training" she has suffered at the hands of the Empire. When Corwin first came under suspicion, she was caught by the Imperial High Inquisitor Tremayne as he rounded up and murdered Corwin's parents. Recognizing that she could be used by the Empire, he sent her to COMPNOR's Imperial Security Bureau (ISB) Re-Education bureau for a light course (by their standards, anyway) of indoctrination. In that course, she came to blame the death of her parents on Corwin, not the Empire, because Corwin had turned to rebellion and engaged in illegal and restricted activities. She now works for the Surveillance branch of the ISB, posing as Moff Balfour's personal aide.

Elena is a little disjointed and disoriented at times as a result of Re-Ed's ministrations. Still, she is frighteningly loyal to Emperor Palpatine's New Order to the exclusion of all else ("To serve the Emperor is sufficient justification for *any* action"). She lives to serve COMPNOR to the best of her ability. Her main ambition is to capture and execute her brother — her hatred is so intense that a "tearful reunion" between the two is highly unlikely.



Elena Shelvay

Type: COMPNOR Operative

DEXTERITY 3D

Blaster 3D+2, brawling parry 6D, dodge 5D

KNOWLEDGE 4D

Cultures 5D, intimidation 6D+2, street-wise 6D

MECHANICAL 2D

PERCEPTION 4D

Con 6D, investigation 7D+1, search 6D+2, sneak 6D+2

STRENGTH 2D

Brawling 4D

TECHNICAL 5D

Security 6D+2

Force Points: 2

Dark Side Points: 3

Character Points: 12

Move: 10

Equipment: Imperial Arms Model 22T4 Hold-Out Blaster (3D+1 damage), encrypted comlink, high-quality evening gown (in storage), ISB security code cylinder, 1,000 credits

Radiation Zone Assault Troopers

Radiation Zone Assault Troops, or “radtroopers,” are a little-known arm of the Emperor’s elite stormtrooper divisions, and like Imperial spacetroopers, they have been trained to handle one of the deadliest terrain types known: heavy-radiation zones. Imperial command long ago identified this terrain type as requiring an elite unit; spacetrooper suits provide ample protection against radiation, but are unsuitable for gravity fields. Consequently, standard stormtrooper armor was modified to provide additional radiation protection by the introduction of a lead-polymer substrate, and the distinctive silver and black battle armor of the radtrooper legions was formed.

The armor may be distinctive, but it is not well-known. Sometimes radtroopers are sent into areas that have been filled with radiation as a result of prior combat or natural conditions. In other circumstances, the Empire may actually fill a battle area with radiation. In either case, often only those wearing spacesuits can survive. Unfortunately, fighting in a spacesuit puts an individual at a distinct disadvantage. Spacesuits are bulky and hamper movement; the radtrooper armor is lightweight, allowing much freer movement, and the superior skills of the radtroopers are usually just as decisive a factor as the radiation. Casualty figures for units that have had to face radtroopers are invariably frighteningly high. The troopers use light weapons (such as force pikes and vibroblades) for rapid assaults where mobility is a prime concern; heavier equipment options are used whenever extra staying power is required or a comprehensive sweep of an objective is necessary.

Another advantage that the radtroopers usually possess is provided by the terrain itself. While modern weapons are quite resistant to radiation, there are limits, and all radiation zones above grade four cause continuous malfunctions in most powered weapons. As a result, radtroopers are given blasters with high power ratings to partially offset the effects of these malfunctions; when even these weapons give out, they simply switch to melee combat, an area where other troops receive minimal training nowadays. This type of engagement further compounds the advantage of their heavier armor.

Certain members of radtrooper heavy assault forces are equipped with standard weapons, but are also given a quantity of explosives to gain entry to the unit’s objective. *All* radtroopers are trained in the use of these explosives. The usual assessment is three satchels of charges plus a number of extra radiation resistant timers. Each satchel contains 10 charges rated at 6D damage;

charges may be combined as per the “Combined Actions” rules on pages 68 to 70 of *Star Wars: The Roleplaying Game, Second Edition*. The charges are often prepared with timers and detonators prior to battle for maximum deployment speed. Thermal detonators are almost never used, as their already notorious volatility is made worse by strong radiation.

Radtroopers use the standard utility belts common to all stormtrooper unit types, which include high-tension wire, grappling hooks, spare blaster power packs, ion flares, concentrated rations, a spare comlink, water, medical supplies, and specialized survival equipment for the terrain encountered. For radtroopers, this survival equipment includes anti-radiation pills, two extra detoxification hypos in case a “hot” area is unexpectedly encountered, a radiation tent, a water purifier, a radiation meter and a few other items to allow survival in some of the most desolate wastes known. Radtroopers can stay active in the field for almost as long as regular stormtroopers.

■ Imperial Radiation Zone Troopers

(Radtroopers)

DEXTERITY 3D

Blaster 4D, brawling parry 4D, dodge 4D, grenade 4D, melee combat: vibroblade 6D+1, melee combat: force pike 7D, melee parry 6D+2

KNOWLEDGE 3D

Survival: radiation zones 6D

MECHANICAL 2D

PERCEPTION 3D

Hide 4D, search 4D+2

STRENGTH 3D+1

Stamina 4D+1, brawling 6D

TECHNICAL 3D

Armor repair 5D, blaster repair 5D, first aid 3D+2, demolition 4D+2

Force Points: Varies, typically 1-5

Dark Side Points: Varies, typically 1-5

Character Points: Varies, typically 5-30

Move: 10

Equipment: SoroSuub Stormtrooper Two blaster carbine (6D+2 damage), 2 concussion grenades (5D damage), vibroblade (STR+3D damage), force pike (STR+4D damage), Radtrooper armor, standard utility belt, survival kit

Imperial Storm Commandos

Imperial Storm Commandos are the Emperor’s answer to guerilla tactics. After the destruction of the Death Star at the Battle of Yavin, the Emperor was forced to acknowledge the effectiveness of the hit-and-fade tactics that the Rebel Alliance used. Consequently, he decided that a commando unit trained in these same methods could achieve spectacular results as well. Selected from the finest stormtroopers, the Storm Commandos are experts at guerilla warfare. They have a reputation for ferocity that few other units can hope even to approach. They are commonly used in anti-Rebel operations, siege-breaking,

Radiation Zone Assault Stormtrooper Armor

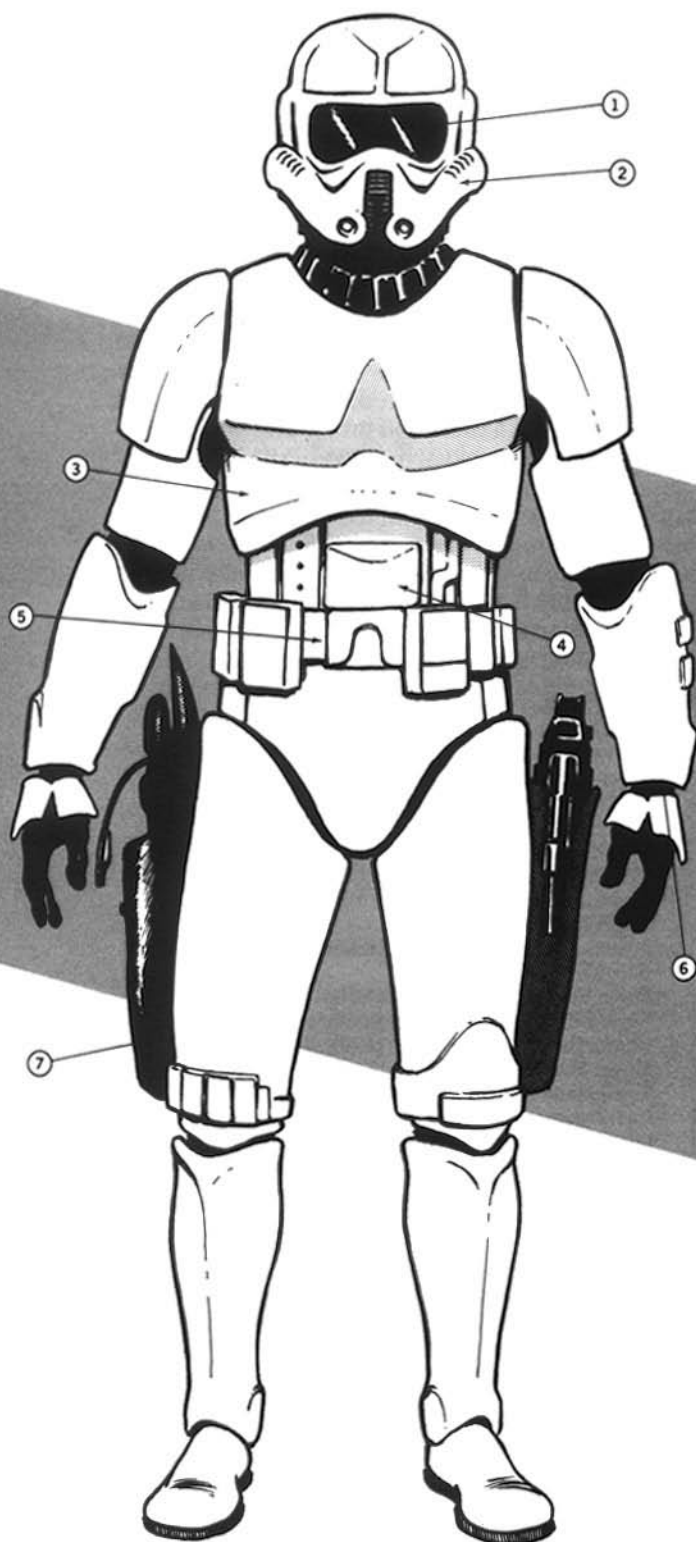

Radtrooper

(Imperial Radiation Zone Trooper)

1. Macrobinocular view plate with blast shield and UV sensors.
2. Stress reinforced helmet with automatic polarized lenses, comlink, and breathing filters.
3. Stress reinforced armor with heat and radiation reflective coating.
4. Heat and radiation cooling unit with energy source and portable environment unit (one-piece wrap-around backpack unit).
5. Utility belt with specialized survival gear, spare breathing filters, concentrated rations, emergency power cells and spare comlink.
6. Black, two-piece temperature-control, radiation sealed body glove.
7. Holstered blaster carbine.

Radtrooper Armor

Model: Imperial Munitions radtrooper armor

Type: Radiation-zone personal battle armor

Cost: Not for sale*

Availability: X

Game Notes: Radtrooper armor protects the head, torso, arms and legs. The armor adds +3D to *Strength* code for all physical attacks and adds +1D to *Strength* against energy attacks. Unless the suit is damaged in combat, it is completely sealed against radiation and atmospheres. The armor is equipped with an atmosphere and moisture filtration/recycler system so that radtroopers can operate freely in heavy-radiation zones. Like standard stormtrooper armor, it reduces the trooper's *Dexterity* code and skills by -1D.

* Radtrooper armor is classified as a military secret, so possession of such armor is punishable by life imprisonment or execution. Those few sets of armor that have reached the black market are believed to have sold for over 50,000 credits. It is believed that this highly specialized armor costs the Empire over 25,000 credits per suit.

Imperial Storm Commando Armor

Storm Commando

(Imperial Storm Commando)

1. Holstered blaster carbine.
2. Holstered blaster pistol.
3. Survival kit including concentrated rations, medpacs, emergency power cells and spare comlink.
4. Explosives pouch.
5. Blast reinforced helmet with sensor pack and "reflec" coating.
6. Blast reinforced cocoon shell battle armor with "reflec" coating.

Not shown: Black, two-piece temperature-control body glove.

Storm Commando Armor

Model: Imperial Munitions Storm Commando armor

Type: Lightweight personal battle armor

Cost: Not for sale*

Availability: X

Game Notes: Based on the light armor of Imperial Scouts, Storm Commando armor is protective (+1D to *Strength* to resist damage) without being restrictive (no penalty to *Dexterity* or related skills). Storm Commando helmets also contain a UV night-sight feature, that allows the troopers to move in darkness with relative ease (+3D to *search* and *Perception* in darkness). Also, the Storm Commando armor is made of a newly-created polymer called *reflec*, which bends most types of sensor probes away from them, rendering them virtually invisible to most light probes, though a fairly determined scan will detect them. In game terms, if the Storm Commandos are not being actively sought, roll an additional +1D to their *hide* and *sneak* checks. The armor is also relatively sound absorbent, with a thin layer of sound baffling built in, enabling the Storm Commandos to move more quietly (add +1D to *sneak*). Their armor is usually black, with no insignia or other unit designations on it, since the Storm Commandos prefer to operate in darkness.

*Storm Commando armor is classified as a military secret and carries the same penalty as possession of raddrooper armor. On the black market, Storm Commando armor is believed to cost upwards of 10,000 credits.

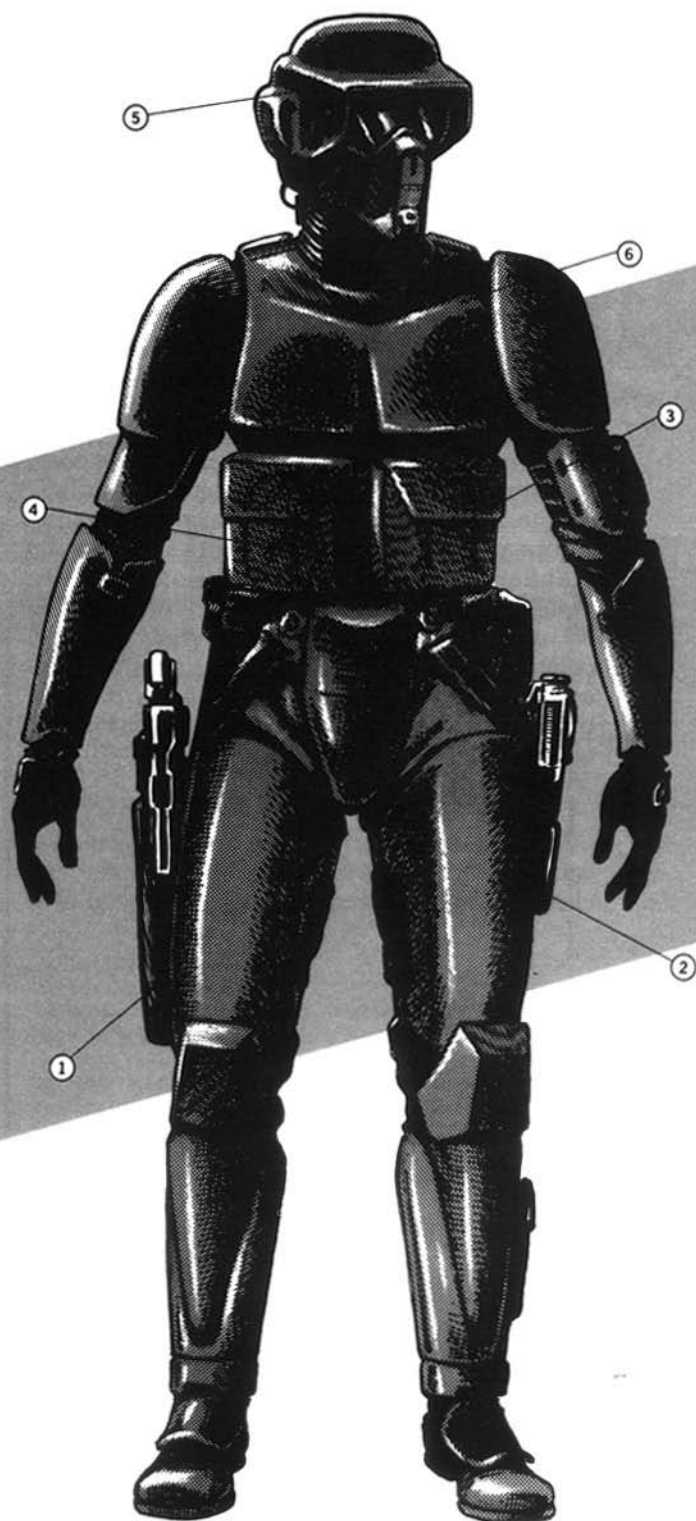

“extractions,” and in Base Delta Zero operations against “hard” targets.

Generally speaking, regular stormtrooper units are used for mainstream military operations such as assaults, battles and “pacifications” on hundreds of thousands of standard worlds. The elite units have been trained for special terrains, including, but not limited to, radiation-contaminated areas, underwater and space operations. As such, they often face smaller-scale missions, such as commando raids.

Specialists

One quarter of Storm Commandos have the standard skills and attributes and are designated “Line” units.

Another quarter are designated “Assault” units, and also have *vehicle blasters 5D+2* and *blaster artillery 4D+2*.

Another quarter have an additional +2D in *hide*, *sneak*, *streetwise*, *security* and *demolitions*, and are designated “Saboteur” units.

The final quarter of the Storm Commando forces are designated “Tech” units and have the standard skills plus an additional +1D to *repulsorlift operation*, as well as *repulsorlift repair 4D*, *droid programming 5D*, *droid repair 6D*, and *computer programming/repair 6D*. Combinations of these four unit types are able to perform practically any small-scale mission on any planet in the galaxy.

Additional Unit Equipment

Assault units carry 2 concussion grenades each (5D damage) as well as the unit commander’s choice of heavier weaponry (where speed is of

the essence lighter repeating weapons and/or grenade launchers may be used to retain mobility).

Saboteur units will have supplies of detonite (often three satchels for every other trooper) and may occasionally use thermal detonators. Saboteurs are particularly resourceful (even for Imperial stormtroopers), and the success of many missions has been assured by a saboteur with a spare charge booby-trapping the objective’s escape vehicle.

Tech units are generally equipped with sophisticated communication gear, computer probes and tools for assisting in sabotage and computerized surveillance of targets.

■ Imperial Storm Commandos

DEXTERITY 3D

Blaster 7D, brawling parry 5D+2, dodge 5D+2, grenade 5D, melee combat 5D+2, melee parry 5D+2

KNOWLEDGE 3D

Survival 6D

MECHANICAL 2D

Beast riding 5D, hover vehicle operation 5D+1, repulsorlift operation 5D

PERCEPTION 3D

Hide 6D+2, search 6D+2, sneak 7D

STRENGTH 3D+1

Brawling 5D

TECHNICAL 3D

Armor repair 5D, blaster repair 5D, first aid 4D, demolitions 4D+2, security 3D+2

Force Points: Varies, typically 1-5

Dark Side Points: Varies, typically 1-5

Character Points: Varies, typically 5-30

Move: 10

Equipment: Blaster carbine (5D+2 damage), blaster pistol (4D damage), Storm Commando armor, standard utility belt, survival kit

Chapter Three

Crime Lords and

Syndicates

Throughout civilized space, there are those who do as they please, with no regard for the law. For those who want illegal or contraband goods, slaves, or any of a number of other questionable goods, there is the "Invisible Market." Driving the market behind the scenes are the criminal organizations, from small smuggling groups to the huge criminal empire of Jabba the Hutt. Here are some of the notable criminals in the Outer Rim Territories.

The Kheedar Ring

Horch of Kheedar was a two-bit crimelord on his home planet, deep in the Outer Rim Territories. He did a bit of slaving, a fair amount of gun-running, some loansharking and so on, but generally speaking he was a small lizard in a very big swamp. His planet of operations, Kheedar, is a minor world with only a few hydrocarbon processing facilities and is thus of minimal interest to the rest of the galaxy. Unfortunately for Horch, hydrocarbon processing facilities were an easy target for the Rebel Alliance to attack. After the destruction of half a dozen other such facilities in the Outer Rim, the Empire decided it had better act to protect the factories on Kheedar before the Rebels destroyed them too.

As a result, a *Victory*-class Star Destroyer, the re-christened *Pestage*, arrived in-system and announced that martial law would be inflicted on the system. Farcically, the planet's ruler, who had always been pro-Empire and had always considered Kheedar an Imperial holding, was a senile old man called King Gordan. He, in his haze, defied the approaching Imperials and swore to fight to the last blaster charge. The captain of the *Pestage* responded by sending its two TIE squadrons to destroy a number of targets, while using the ship's concussion missiles to flatten some of the more prominent landmarks of the planet. The world surrendered unconditionally inside forty minutes. But Horch's fortress, being large and having a number of laser emplace-

ments for defense, was one of the targets of those missile assaults.

Meanwhile, an up-and-coming young bounty hunter named Noval Garaint was bringing in a number of prisoners to the crimelord just as the Imperial assault started. There were graphic displays on the holovids of the missile assaults on a number of targets, including Horch's palace. Garaint's prisoners tried to escape in the confu-

Krail 210 Personal Armor

Model: Modified Krail Armory Model 210 personal armor

Type: Modified personal battle armor

Skill: Powersuit operation: Krail 210 armor

Cost: (with all modifications) 26,000

Availability: Basic suit is "X" (illegal) on most planets; modified suit is unique

Game Effect:

Basic Suit: Protection +2D to *Strength* for energy attacks, +3D to physical attacks; -1D to *Dexterity* and related skills. Suit has a Move of 15, with movement rolled on *powersuit operation* skill.

Power Suit: +1D to *lifting*.

Sensor Pod: +1D to *search*

Integral Internal Line Slinger: 20-meter range. Can attach to grappling or magnetic hooks. Uses *missile weapons* skill.

Jet Pack: Has a Move of 100 meters horizontally, 70 meters vertically. Uses *jet pack operation* skill, base difficulty is Easy, modified by obstacles. Has 20 charges, can expend up to two per round.

Winch: Capable of lifting 100 kg (i.e. Garaint and his equipment only)

Internal Dual Force Blades: STR + 3D damage. Moderate *melee combat* difficulty.

Sealed Enviro Filter: Filter system can block out harmful molecules, or in case of insufficient or deadly atmosphere, the suit can completely seal, drawing upon a two-hour internal supply of oxygen.

Capsule: Noval Garaint's custom modified suit of armor has given him the critical advantages he has needed during his career. Most of the suit's features are concealed in hidden panels so that it appears to be a standard suit of armor. When he uses his special gadgets, it often allows him to quickly and easily capture his prey.

Noval Garaint's Armor

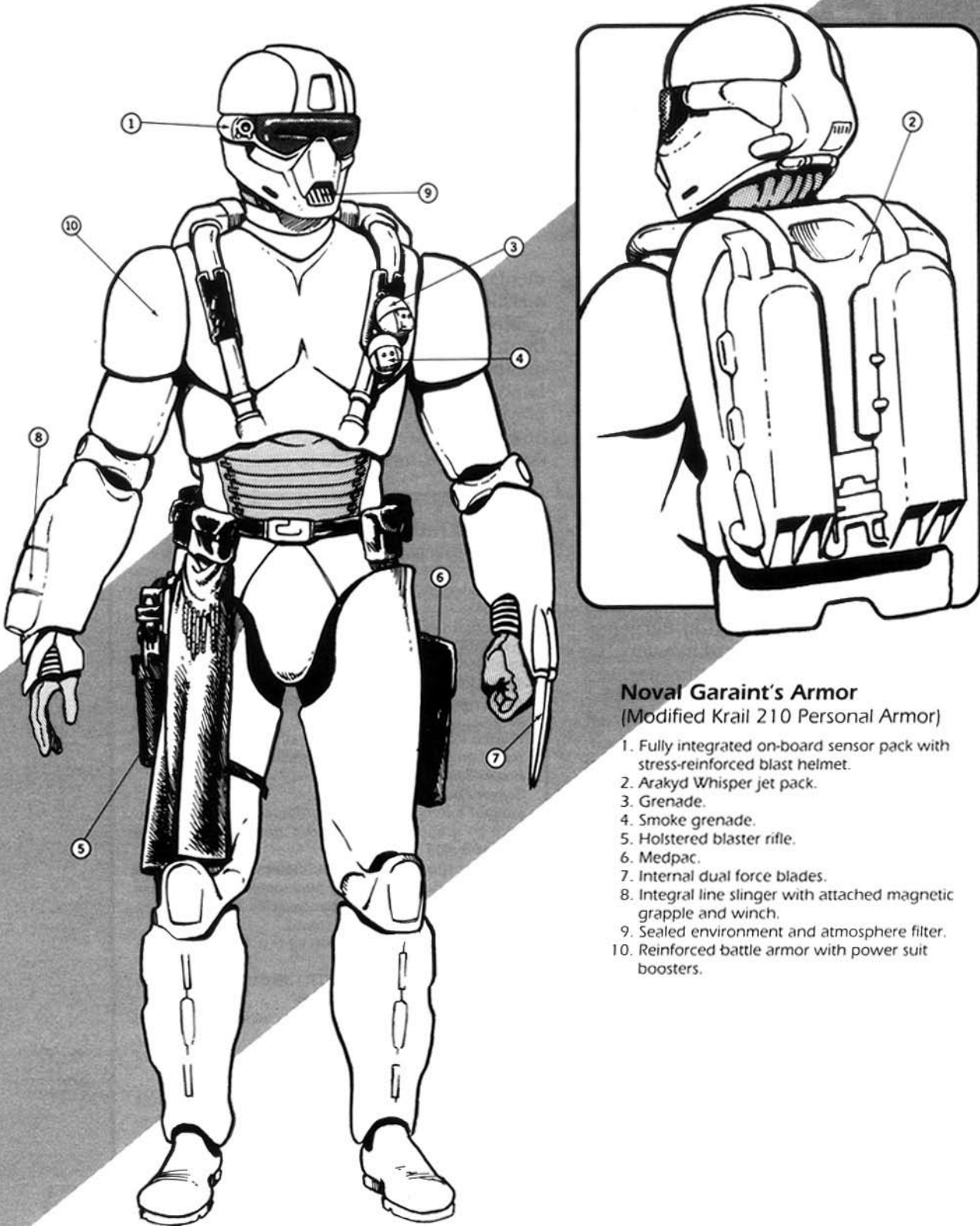
**Noval Garaint's Armor***(Modified Krail 210 Personal Armor)*

1. Fully integrated on-board sensor pack with stress-reinforced blast helmet.
2. Arakyd Whisper jet pack.
3. Grenade.
4. Smoke grenade.
5. Holstered blaster rifle.
6. Medpac.
7. Internal dual force blades.
8. Integral line slinger with attached magnetic grapple and winch.
9. Sealed environment and atmosphere filter.
10. Reinforced battle armor with power suit boosters.

sion. Garaint, realizing that a power vacuum was developing in front of his very eyes, let them go. He had left a thermal detonator on a time-delay fuse near the main drive of their ship anyway, so it seemed unlikely that they'd be able to fix their ship in time to escape off-planet.

He made his way to Horch's palace and started carving himself a path to the throne. When the stormtroopers arrived, he had already done most of their work for them. Horch was captured, his more intractable henchmen dead, and Garaint, bounty hunter license in hand, was able to report, "Everything is under control here, officer," to the confused unit commander. The Imperials moved on to their next objective, and Garaint finished mopping up.

Garaint has now fully taken over the remnants of Horch's empire, and is rapidly recruiting other bounty hunters and mercenaries into his organization. Horch has become addicted to a rare and expensive form of spice liquor, and is kept on as a figurehead leader. He still conducts his business, holding court just like Jabba does, and few people guess that the armored bodyguard who always watches over him is a puppeteer, pulling all the strings of this wretched creature.

Horch is entirely under Garaint's control now; even his periodic rebellions and tantrums are engineered by his new master and used to good advantage. Garaint knows *everything* that Horch does, even when Horch believes he is acting without Garaint's knowledge. An extremely smart bounty hunter is running a crimelord's operation, while giving the impression that the crimelord is still in charge.

Efficiency of the organization has risen, the organization is becoming leaner, and it is expanding into the areas that Noval Garaint is good at: enforcement, slaving, syndicate work, and military operations. Because most of the staff are now licensed bounty hunters, Imperial harassment is also practically a thing of the past. After all, the Imperials don't mind corruption, or gun-running, or slavery, or protection rackets, or indeed anything, provided they are done discreetly. This is something Garaint understands and can arrange; few crimelords are willing to be so accommodating. As a result, Noval Garaint is quickly becoming extremely rich, extremely powerful, and extremely dangerous.

Noval Garaint is a tall and athletic Human, with gold-blond hair, blue eyes and rugged good looks. However, it is extremely unlikely that he will ever be seen out of his battle-armor. He is cold, calculating and vicious in the extreme. Violence is not an activity for him; rather, it is a way of life ("The warrant out on you says 'dead or alive,' champ. Which will it be?")

■ Noval Garaint

Type: Bounty Hunter

DEXTERITY 4D

Blaster 8D, dodge 8D, grenade 5D, melee combat 5D, melee parry 5D, missile weapons 5D+2

KNOWLEDGE 2D+2

Alien species 3D, bureaucracy 3D, cultures 3D, languages 3D, planetary systems 5D, streetwise 6D, survival 3D, value 6D

MECHANICAL 2D+2

Astrogation 4D, jet pack operation 4D+2, powersuit operation 6D+1, repulsorlift operation 4D+2, space transports 6D, starship gunnery 4D

PERCEPTION 3D

Bargain 5D, command 6D, con 4D, hide 6D, search 7D, sneak 6D

STRENGTH 3D+2

Brawling 4D+2, climbing/jumping 5D, lifting 5D, stamina 4D+2

TECHNICAL 2D

Armor repair 4D, blaster repair 3D+2, security 4D+2

Force Points: 2

Dark Side Points: 4

Character Points: 8

Move: 10

Equipment: Blaster pistol (4D damage), blaster rifle (5D damage), hold-out blaster (3D+2 damage), grenade (5D damage), smoke grenade, thermal flare, medpac, modified Kraill 210 personal armor*

* See page 32.

Horch of Kheedar

Horch of Kheedar has fallen far since that fateful day that the Empire assaulted Kheedar. His criminal empire fell into ruins when the concussion missiles began falling to the planet's surface. His loyal hired lackeys panicked during the assault, and before he knew it, Horch was face-to-face with Noval Garaint. Soon, he found himself enslaved by the ambitious bounty hunter, doing his bidding. Now, Horch seems unable to concentrate on anything but the spice liquor. He seldom remembers the details of any of his business deals — he answers only to Noval, and has no choice in his fate.

Horch of Kheedar. All stats are 1D except: *Bargain* 2D+2, *command* 4D, *con* 2D+2. * *Move:* 8.

* Horch's stats have been reduced due to his addiction to spice liquor

Reuss VIII

The planet Reuss VIII was once a lush and green planet, known for its scenic splendor and mild climate. In those days, Reuss VIII was a prime food producer for several colony worlds and gained a reputation for being a pleasant, if boring, place to visit.

The industrial giants of the Old Republic figured out that with large amounts of land on Reuss essentially "up for grabs," they could purchase sites for food production facilities at a low price. In a matter of a few years, the planet had been



■ Horch of Kheedar—once a crimelord, now a mere figurehead.

bought out from under the Reussi, the near-Human natives of the planet. Allowed to remain on their land as tenants, the Reussi have seen their planet devastated by ruthless companies during the last few hundred years. Now the world is also home to another kind of poison — the criminal organization of Torel Vorne.

Reuss VIII is now the industrial juggernaut of Portmoak Sector. The Reussi communities have ceased to exist, starved out by the cessation of food production on their home planet. Reuss VIII now stands as a warning of just how badly a world can be abused. The atmosphere is loaded with toxins and the rain is highly acidic. While the rain never really stops, it sometimes slackens to a fine mist, which is still dangerous to breathe,

but can be tolerated for short periods. The acidity also varies, so checking the local forecast is a matter of some importance. Going out in the mist should not be attempted without a respirator, as the mist destroys lung and throat linings.

On low contamination days, exposure to the air's mist without a breath filter causes 2D damage per six hours of exposure. After two weeks of exposure, the damage to the lungs is irreversible without replacement by cybernetics. On high contamination days, exposure to the rain without a full environment suit causes 2D+2 damage per round of exposure.

The people of Reuss VIII are very poor, and are effectively slaves of the Reuss Corporation. Average life expectancy is around forty years, all of it spent without seeing a single plant or growing thing. Reuss VIII's entire land surface is covered with factories, refining plants, inefficient waste incinerators and crumbling blocks of skyscrapers. Often, the industrial belts are so huge that they merge into one another, leaving the residential neighborhoods as small islands of habitation in a sea of factories. The planet is also a major conduit for illegal goods being smuggled to the Core Worlds. The vast local influence of crimelord Torel Vorne ensures that customs regulations remain fairly lax.

At the bottom of Reuss VIII's society are the Rust Rats: People even Vorne can't be bothered with. They are mostly children who have no place to go. Their parents have died or been kicked out of their blocks for rent default and they live hand-to-mouth in the crumbling remains of corroded buildings, stealing food, picking pockets and begging for food and money. Generally, the average Rust Rat is slowly being killed by acid burns and lung diseases, but that is of no concern to those who make decisions on Reuss VIII.

The Rust Rats. All attributes and skills 1D except: *Dexterity 3D, pick pockets 5D, survival: Reuss VIII 5D*

■ Reuss VIII

Type: Industrial nightmare
Temperature: Hot
Atmosphere: Type III (breath mask required)
Hydrosphere: Moderate
Gravity: Standard
Terrain: Urban
Length of Day: 20 standard hours
Length of Year: 210 local days
Sapient Species: Humans, Reussi (N; near-Humans)
Starport: Stellar class
Population: 25 billion
Planet Function: Manufacturing
Government: Organized crime (Torel Vorne)
Tech Level: Information
Major Exports: Mid tech
Major Imports: Breath masks, food, water

Torel Vorne's Organ Donation Policy

Torel Vorne has a "well-run" and efficient organ donation scheme, which impoverished traders sometimes find wise to donate to. Torel Vorne is willing to forgive bad debts for a small contribution. The rates for organs range from perhaps a few hundred credits (for seemingly unimportant organs) to several thousand credits for vital and non-duplicated organs, like hearts and stomachs.

A contribution to this scheme can yield a credit up to 25,000 credits. When the character undergoes the surgery, roll damage to see how careful Vorne's surgeon was.

Value of Donation	Damage
<2,000 credits	1D
2,000-5,000	2D
5,001-10,000	3D
10,001-15,000	4D
15,001-20,000	5D
20,001-25,000	6D

No one knows why Vorne has implemented this particularly gruesome scheme, but many traders who have fallen into disfavor with the crimelord have taken their chances with cybernetic replacement parts rather than have their lives ended by Vorne's enforcers.

■ Deral Reiko

Type: Criminal Informant

DEXTERITY 3D

Blaster 4D, melee combat 4D

KNOWLEDGE 4D

Bureaucracy 4D+1, business 5D+2, streetwise 5D+2

MECHANICAL 2D

PERCEPTION 4D

Bargain 5D, con 6D, gambling 5D, search 6D

STRENGTH 3D

TECHNICAL 2D

Equipment: Hold-out blaster (3D damage), datapad (with encrypt codes to a number of communication up-links), comlink, 3,500 credit voucher

Capsule: Deral Reiko is a Reussi (near-Human) with short black hair and blue eyes. He is a casual dresser and is of the type that takes no strenuous exercise if he can help it but somehow keeps himself fit. He appears to be, in all respects, a successful, high-powered executive. As a boy, Deral did "odd jobs" for Torel Vorne, crime boss of Reuss VIII. He became a sort of protege and by the time he was 15, he had decided that the key to any successful empire, be it a business, military or political entity, was information. A year later, he left his homeworld to become one of Vorne's agents.

His ruthless behavior and his talent for finding out buried facts made him a useful addition to Vorne's off-planet assets ("Of course, I maintain the highest standards of honesty and confidentiality. Your secrets are safe with me.") He still does contract work for Vorne, but has branched out on his own as an information agency for bounty hunters

Torel Vorne

Type: Crimelord

DEXTERITY 3D

Dodge 4D

KNOWLEDGE 4D

Bureaucracy 5D, streetwise 4D+1, streetwise: intimidation 6D, value 6D

MECHANICAL 3D

Repulsorlift operation 4D

PERCEPTION 4D

Bargain 6D+2, command 5D+2

STRENGTH 2D

TECHNICAL 2D

Character Points: 5

Move: 8

Equipment: Datapad, SoroSuub Q-2 hold-out blaster (3D+2 damage, hidden in left sleeve), 2,000 credits

Capsule: Torel Vorne is a short, dark Reussi. He has dark, stringy hair that he is slowly losing (though he doesn't seem too bothered about that; personal vanity is "beneath him"). His clothes are always too big for him, and he has watery blue eyes that never blink. He always wears a breath mask when he is outdoors or when he is meeting someone in person.

Torel is a despicable crime lord whose only concern is the profit or loss on a transaction, with no thought as to what the involved goods may be.



and other criminal figures. Many of the best hunters and syndicates in the Outer Rims count him among their more useful contacts. He is superficially friendly in a cold-blooded way, but his only loyalty is to his credit balance: he doesn't even "stay bought" if he gets a better offer ("Information's my trade. Who do you want to know about and how much can you pay?")

Shownar

The crystal planet Shownar in Parmic Sector is a place of stunning natural beauty that not even the introduction of galactic civilization has dimmed. The planet is unique, consisting of three large land masses that are entirely composed of a rare form of Vertag crystal. The crystals formed in spires several kilometers tall, which at night glow with faint blue light. The wind rushing between the spires at higher altitudes creates a haunting, ghostly harmonic wave, called "Shownar Lullaby," which is incredibly beautiful and soothing.

Most spectacular, though, is the planet's proximity to the celestial oddity, the Torch Nebula. The Torch Nebula is an immense cloud of gases and elements, or "star stuff," that at night fills Shownar's sky with a spectacular light show of blue and red fire.

The planet is ruled by Oro Freatt, a shrewd

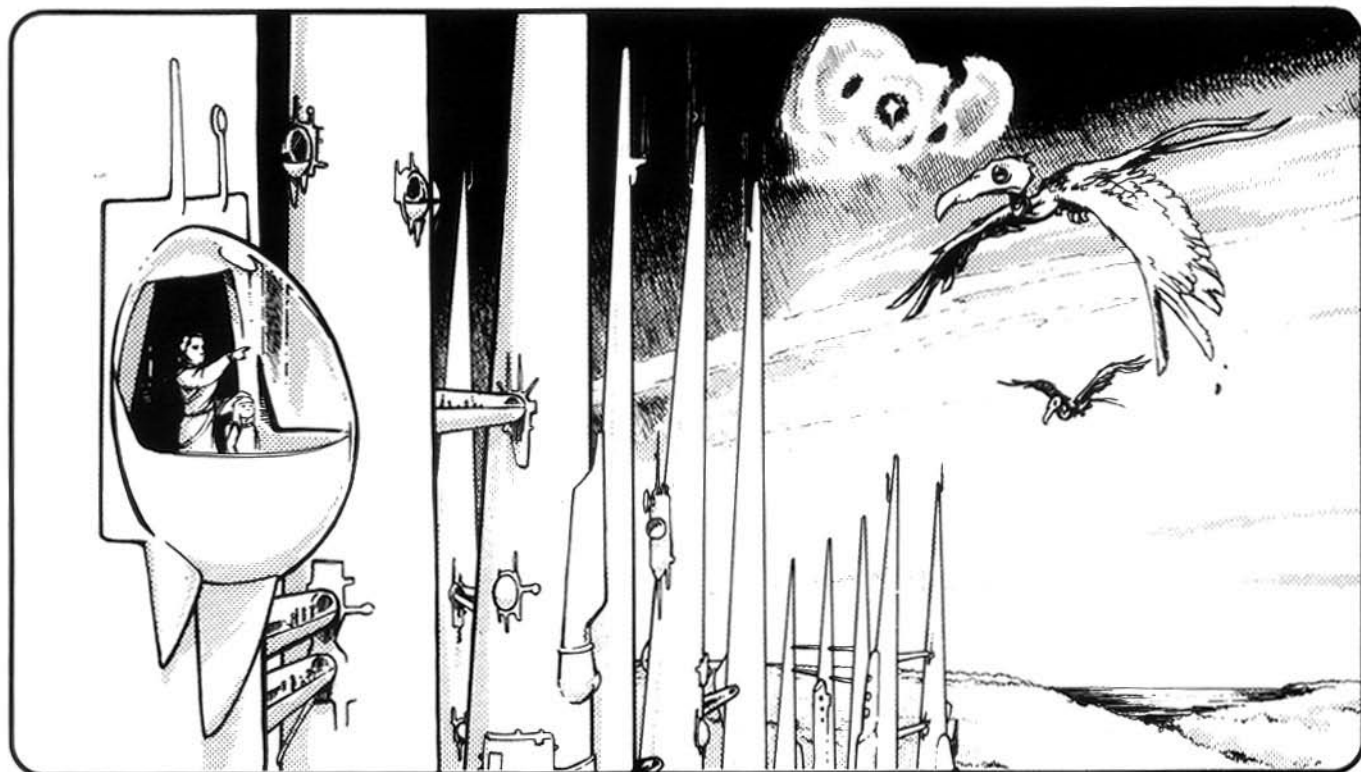

businessman and minor player in galactic crime. He has turned Shownar into a trade and tourism nexus in just a few decades. Indeed, Oro Freatt's line of souvenir holocubes ("View of the Torch Nebula from the Nebula Hotel, Shownar") is the main reason behind the view's fame. Almost any Core Worlder who travels to Parmic Sector returns with one of these holocubes (they're almost as common as over-garments bearing the legend, "I've been to (insert name of planet) and all I got was this crummy tunic!")

For the more jaded tourist, the planet offers more than natural beauty. Freatt has made sure that the local laws (over which he has all say) are open to gambling and other vices. Law enforcement officials are likewise encouraged to overlook "minor" smuggling infractions. As a result, Shownar is a gambler's paradise with an extensive criminal network. In the "undercity," a network of cheap memory-plastic buildings controlled by Oro Freatt, smugglers and various unsavory characters from across the region meet to sell whatever goods and services they can. The undercity is a welcome change of pace from other crime centers like Mos Eisley because, unlike Tatooine's Jabba the Hutt, Freatt isn't particularly concerned with creating a huge criminal empire. He is quite happy with his planetary empire, and he makes sure that he receives appropriate compensation for business transacted on his world. In the "overcity," the upper levels of the city where moderate income and affluent

tourists congregate, Shownar is a placid world with a "family atmosphere." The more affluent visitors stay at the Nebula Hotel, a renowned establishment which commands a breathtaking view of the planet's surface as well as the Torch Nebula.

Naturally, experienced spacers treat the whole affair with the disdain worthy of such a tourist trap, but they often find it worth their while to stop for some business.

The terrain of Shownar is distinct, consisting almost entirely of crystalline spires that tower several kilometers in the air. While most buildings on Shownar are built on the spires, the native Shownarri in many cases live inside the crystal spires themselves (Oro Freatt lives in such a building).

■ Shownar

Type: Temperate paradise
Temperature: Temperate
Atmosphere: Type I (breathable)
Hydrosphere: Moderate
Gravity: Standard
Terrain: Crystal spire formations
Length of Day: 25 standard hours
Length of Year: 370 local days
Sapient Species: Humans, Shownarri (N, near-Humans), various aliens
Starport: 1 Imperial class, 2 stellar class
Population: 3 billion
Planet Function: Entertainment, tourism
Government: Private ownership with organized crime leanings (Oro Freatt)
Tech Level: Space

Major Exports: Souvenirs

Major Imports: High technology, luxury goods, tourism

■ Oro Freatt

Type: Successful Entrepreneur

DEXTERITY 4D

Blaster 4D, dodge 7D

KNOWLEDGE 3D

Bureaucracy 5D+2, streetwise 7D, value 5D+2

MECHANICAL 3D

PERCEPTION 3D+2

Bargain 5D+2, command 4D, con 6D

STRENGTH 2D

TECHNICAL 3D+2

Force Points: 2

Character Points: 10

Move: 10

Equipment: 700 credits (on hand), credit voucher, datapad, blaster pistol (4D damage)

Capsule: There are plenty of slime ball crime kings in the galaxy, but Oro Freatt is just a ball of slime. He is small, oily and officious, and is living proof that there are things out there that are even more irritating than mouse droids. Always dressed in garish, tasteless clothing, and flashing a lot of cash, Freatt is in serious trouble if the Empire ever moves into his "territory" in force. As a result, he makes every effort to appear subservient and loyal to the Empire ("Rest assured, my dear Moff, there is positively *no* treasonous activity on Shownar"). He has made a fortune by transforming Shownar into a tourist trap and crime center. Somehow, he has managed to keep other criminal organizations from taking control of the world despite his reluctance to use armed force.

Freatt's Organization

Oro Freatt has been able to maintain power and the image of Shownar as a beautiful, safe playland through a well-run and highly disciplined organization. Oro has several thousand individuals working under him, but almost all of them are trained business people instead of simple hired thugs and petty criminals. As a result, his people are smart enough to see that the big profits come from keeping the planet peaceful and pleasant for businesses of all kinds — legal and illegal.

These people cut the specific deals that are necessary to maintain the planet — one organization will get control of the labor unions, another will get control of the processed food industry, another will get control of the transportation network. In turn, Freatt's organization gets a percentage for all business conducted by a particular organization. Freatt also directly controls specific high profit industries, such as communications and energy. Since Freatt also owns all property on the planet, he also collects a huge sum of money for rentals from all tenants.

In order to keep the Empire happy, Freatt sends a respectable percentage to the Imperial tax coffers. Freatt quickly bribed Shownar's Imperial governor, and therefore is able to shelter an immense amount of money through underreporting income and laundering funds through a variety of shadow transactions. Despite Freatt's deceptions, the Empire gets more than enough cash from Shownar to make the sector government happy.

This structure has turned out to be in everyone's best interest: each organization isn't making as much money as it could if it seized control, but there are still handsome profits to be made. Additionally, Freatt has made his organization indispensable in that it keeps the peace: If one organization were to try muscling in on control of Shownar, Freatt would send all of the other organizations after it since their profits would be at stake too.

Freatt is very concerned with appearances. He invests a sizeable amount of his profits into keeping the city beautiful and peaceful. The local police will overlook smuggling, but they handle violent criminals harshly and crack down on pick pockets and other common thieves. While the criminals own this world, they understand that the way to make money is to make this place appealing to honest people who simply want to gamble in beautiful surroundings during their vacation.

Chapter Four

Galactic Business and

Corporate Families

There are millions of corporations in the galaxy; thousands of them are big enough to count as megacorporations, some of which own systems or entire sectors of space. Among the megacorporations, the most profitable fields are transportation, ship-building, mining, weapons manufacturing and bulk food processing.

Many of these companies are publicly owned and administered by a board of directors. Others are owned by private families or individuals. Still others are government administered, owned by trade guilds, or guided by some other more unusual method of operation.

In every case, the nature of the corporation is likely to be dictated by the personalities of the people at the top (Gastess' Finance, Inc. being a particularly unpleasant example of this). These individuals and companies are worth mentioning because the characters may be directly affected by the decisions made by these companies, or the executives of these companies may be particularly flamboyant individuals in a sector.

Also bear in mind that certain characters of an aristocratic bent may encounter these people or their families. These people are all excessively rich, and often extremely bored. "If Daddy runs the company, and gives his daughter a *mere* million-a-week allowance, how *is* a girl supposed to spend it?"

The answer is usually in casinos and clubs, on luxury liners and pleasure planets, on buying expensive toys and playing at being a trader, on buying a little company to run for something to do, on shopping and clothes and jewelry, on buying new slaves, at swoop races and gladiatorial contests, at balls and feasts, on bail money after being caught breaking some tedious local law ... the choices are simply *limitless*.

Planets like Sorotarr VI, home of the Game and a real gamblers' paradise, are usually packed full of Moffs, corporate executives, Imperial nobles, Fleet Admirals, crooks, and aristocrats, all of them incognito, and most of them desperate for

something, *anything*, interesting to happen. Adarlon, in the Minos Cluster (*Galaxy Guide #6, Tramp Freighters*) is much the same, and so is Harloen, the swoop racing capital of the Outer Rim.

It should not be surprising that in a galaxy where corporations own entire sectors, the directors of those corporations are some of the most powerful people alive. As the government of the galaxy actively encourages the ruthless and systematic exploitation of planets and populations, it should come as no surprise that some of those people are thoroughly unpleasant. However, there *are* still companies out there that believe in the principles of enlightened self-interest. The following is a small selection of corporations and corporate families in the Outer Rim Territories, ranging in character from enlightened to despotic.

Fabritech, Inc.

Kvarn Mandel is the current head of Fabritech Inc., a company that manufactures sensors and control systems for starfighters, particularly the Empire's TIE fighter. A stately, distinguished gentleman, he is a staunch supporter of the New Order of Emperor Palpatine, and it is because of this that he landed the Sienar TIE fighter subcontract that put his company on the map.

Because of the company's success at manufacturing sensors and control modules for the TIE fighter, it has branched out into the fields of navigational software and gunnery modules for capital starships, which the Empire is buying at a frightening rate. Fabritech is clearly a company with a future as far as the Empire is concerned.

The Mandel family mansion is in the labyrinth of corridors in the underground city of Fabrin on Thorgeld I. Mandel travels regularly to the company's sector headquarters, but always manages to return home at least once a month. He is totally devoted to his wife Emlyn and his four children. However, Mandel's life has one great,

unresolved tragedy. His youngest daughter, Samire, disappeared without a trace eleven years ago (at the time, she was 16).

His youngest son, Simmin, now 29, has been looking for her ever since, and recently hired the Skine Bounty Hunter College to help him. He is convinced that the lack of evidence pointing to Samire's death is cause for hope, and during the last decade he has received sufficient fragmentary hints to keep him from giving up.

Kvarn Mandel strongly disapproves of his son's search for conclusive proof. This is partly because he has convinced himself that his daughter is dead. He hates to see the pain of reopened wounds that Simmin's occasional finds cause the rest of the Mandel family.

The other reason is that Kvarn Mandel believes deep down that Samire may actually have joined one of the organizations affiliated with the blasted Rebel Alliance. This pricks his conscience since Fabritech owes its success to the Empire. Simmin Mandel has completely overlooked this possibility, but unfortunately if he were to realize what the true story might be, he would be torn between his desire to find out what *really* happened to his sister and his loyalty to his father and the rest of the family.

Drever Corporation

The Drever Corporation is one of the smaller weapons manufacturing concerns in Parmel Sector, and specializes in small blaster and blaster cannon technology, with a few entries in the field of plasma-based cutting tools. The company's products are generally reliable but unspectacular, with one exception: the Phoenix Plasma Punch.

Marred with an uninspired name, the Plasma Punch is nonetheless an excellent and useful tool. The Phoenix fires a circular stream of plasma energy which allows it to cut circular holes in virtually any material at close range, including magnetically sealed materials. The hole can have any diameter from three to 30 centimeters.

It is particularly useful for Imperial Customs officials trying to board vessels, but it is impractical as a weapon because of its limited range and extremely high power consumption rate (the unit can only be activated twice and can run for a maximum of ten minutes before requiring a 6-hour recharge). Imperial personnel who have used the Phoenix swear by it as *the* safest and most effective means of breaching magnetically sealed materials. Unfortunately the company hasn't had the inclination to promote the tool, and thus it has cut back on production due to unsatisfactory sales.

The man who invented the Plasma Punch is Madel Wharen, and until recently, he was on the

Kvarn Mandel

Type: Corporate Executive

DEXTERITY 2D

Blaster 3D

KNOWLEDGE 4D

Alien species 6D+2, bureaucracy 7D, business 8D+1, cultures 6D+2, value 6D

MECHANICAL 3D

Space transports 5D

PERCEPTION 4D

Bargain 6D+2, command 7D, persuasion 6D+2

STRENGTH 2D

TECHNICAL 3D

Computer programming/repair 7D

Force Points: 1

Character Points: 3

Move: 10

Equipment: Fancy clothes, datapad with transmitter link to Parmel Sector Stock Exchange, hold-out blaster (3D+1 damage), 2,000 credits

Capsule: Kvarn Mandel is an aristocratic man and is no stranger to power. He is very courteous in his dealings with other people, but is ruthless enough to run one of the most up-and-coming corporations in the Outer Rim Territories. He always dresses in flowing capes, brightly colored clothes of high quality, and high leather boots. His grey hair is pulled into a long pony tail, and he has a mustache and goatee.



Drever Corporation's Board of Directors. He is a quiet but determined supporter of the Alliance. While he cannot publicly endorse the Alliance, he constantly lobbies for business policies that would indirectly aid the Alliance and hinder the Empire. This has led to some blazing arguments with his erstwhile business partner, Jenson Drever II, the current Drever managing director. These fights resulted in Wharen being transferred to one of the corporation's backwater research and development (R&D) stations, where he is now stuck doing development work.

Actually, this is partly the reason behind the solid quality of Drever's product line: Wharen is extremely good at finding flaws in items, and then finding cheap and simple ways of fixing them. However, he has always fancied himself as an inventor (in fact, he *is* much better at development work).

The Rebel Alliance knows of Wharen's leanings and would like to recruit him into their organization. This is, naturally, more complicated than it sounds. First, there is Wharen's family: the Rebel Alliance also has a vested interest in rescuing his wife, Bea, and young son, Padyn (who are closely watched by Imperial Security).

The second problem is Wharen himself. As per



Jenson Drever II

Type: Corporation Executive
DEXTERITY 2D
KNOWLEDGE 4D
 Alien species 6D, bureaucracy 6D, business 8D, value 7D
MECHANICAL 3D
PERCEPTION 3D+2
 Bargain 7D, command 5D+2
STRENGTH 2D
TECHNICAL 3D
 Computer programming/repair 5D
Character Points: 3
Move: 10
Equipment: Datapad, 2,000 credits, business suit
Capsule: Jenson Drever II is a stocky, short near-Human, with greenish-gray skin and straight, short brown hair. He is generally a

calm, rational and almost emotionless individual. However, when things don't go his way he is known to be extremely stubborn or even fly into a fit of rage. While not the most successful businessman in the galaxy, Jenson Drever II is still a competent leader and a shrewd planner. He is not as knowledgeable as he would like about the technical aspects of his company's products, but he is most adept at *selling* these products. Outside of his business dealings, Drever has no interests. He has no family or close friends (save for Madel Wharen, but their relations have been severely strained lately). Cold and calculating, Drever is a difficult adversary, and a highly intelligent business executive.



Madel Wharen

Type: Eccentric Researcher
DEXTERITY 2D
KNOWLEDGE 3D+2
MECHANICAL 3D
PERCEPTION 3D+2
 Persuasion 6D
STRENGTH 2D
TECHNICAL 4D
 Blaster engineering (A) 7D+1, blaster repair 8D, computer programming/repair 8D, droid programming 6D+2, droid repair 8D, machinery engineering (A) 6D+1, machinery repair 7D+1, security 8D
Character Points: 3
Move: 10
Equipment: Datapad, 2,000 credits, business suit (wrinkled), lab coat
Capsule: Madel Wharen is a thin, gangly, grey-haired engineer. He is a genius with all things mechanical. He is usually wearing a lab-coat and rumpled, three-day old clothes. He always carries a datapad and tends to break off

in the middle of a sentence to putter around with an idea at a nearby computer terminal ("OK, so if I cross-wire a DDX pulse modulator with the flux control module, maybe add in an integrated power flow control chip to the microprocessor, that should give me twice the power output with a ... hmmm ... 225.6 variance ... uh, I'm sorry, did you say something to *me*?"). Wharen is erratic, temperamental and brilliant, and fancies himself an "inventor" rather than a "corporate drudge." He has no tolerance for corporate executives who care more about profits and procedures than producing quality products ("So what, yer' a fancy Corporate Exec? Can you fix a busted C-227 motivator for an agriculture droid? Can you? I didn't think so! So quit *buggin'* me! (Turns away, mutters) little pimple-faced, credit-countin' ...").

standard practice for the ISB, they have introduced a Surveillance agent onto the Drever Corporation Board. This agent has been in place for several years and is well aware of Wharen's loyalties. Naturally, Wharen's work at R&D is being closely overseen by several other ISB agents, and the Empire fully expects the Alliance to try an extraction at some point. Consequently, the ISB Surveillance agents have access to Investigations resources and are able to call on Drever's internal security forces.

The Alliance has also been considering a radically different approach. Wharen commands the loyalty of a very large portion of Drever's staff, mainly because of his high skills as an engineer

and his ability to consistently engineer profitable products. Therefore, it might be possible to oust Drever and install Wharen as the controlling force in the firm.

This would be *very* distasteful to the Empire. Changing the situation would involve a particularly unsubtle form of Imperial takeover of the company, which the Empire is hesitant to do because Drever is particularly well liked in the corporate culture of the Empire. A takeover would send a clear and unpalatable message to many other corporations that the Empire needs to maintain order. The only viable alternative for the Empire is to quietly dislodge Wharen, which would lead to a very dangerous internal power

struggle and increase the likelihood that the Empire would get caught in the act.

Gastess' Finance, Inc.

Gastess' Finance, Inc. regularly breaks its own short-term and long-term performance records on the Parmic Sector stock market. Unfortunately, its methods of operation leave a lot to be desired.

Gastess' Finance, Inc. specializes in hostile takeovers. It buys well-run, successful companies, fires their management, runs them for short-term profit until the staff and machinery are worn out, and then sells the company if it can or puts the company into voluntary liquidation if it can't be sold. Then it repeats the whole process again with another company. The resulting *huge* short-term profits are siphoned off into the parent company, leaving behind a trail of shattered dreams and broken lives. Gastess' shares, needless to say, are highly sought after.

The company is now big enough that it can take over *planetary* corporations. Unfortunately, planetary corporations cannot be fully liquidated in the way that most other concerns can be. Once Gastess' has finished with a world, the people are trapped in the ruins, and have absolutely no chance of repairing the damage or rebuilding their homes. This leaves them spiralling into a cycle of debt and tax arrears, and eventually condemns them to Imperial labor camps. This may be the reason behind the Empire's tacit approval of Gastess' methods: Imperial demand for cheap labor is seemingly unlimited.

The corporation is run by a "blind" Gotal named Sarlim Gastess ("blind" in this case meaning with non-functioning head-cones, a serious but extremely rare disability among the Gotal). Gastess functions quite well among members of species other than his own, despite his generally poor eyesight and hearing. Members of his own species are terrified of him; by Gotal standards, he is a clinical psychopath.

Directly underneath Gastess are the directors he uses to manage the companies he takes over. They are, in their way, just as unpleasant as Gastess, and are often significantly more inventive when it comes to stripping a company of every conceivable asset. Foremost among this group are the three Harmion brothers — Halleb, K'yne and Sarell. These three, along with their wives and families (Sarell is the only one who is still single and even *he* has an obnoxious girlfriend), really seem to relish the destruction and anguish they cause.

Kina Margath

Kina Margath is a high-powered executive, always immaculately dressed, and always with an aura of businesslike professionalism about

Sarlim Gastess

Type: Ruthless Business Executive

DEXTERITY 2D

KNOWLEDGE 4D

Bureaucracy 7D, business 8D+2, intimidation 7D+2, value 8D+2

MECHANICAL 2D

PERCEPTION 4D

Bargain 6D+2, command 7D, persuasion 6D+2

STRENGTH 2D+2

TECHNICAL 2D

Special Abilities:

Mood Detection: Gotal can read the moods of other individuals. See page 90 of the *Dark Force Rising Sourcebook*.

Fast Initiative: Gotal receives +1D when rolling initiative against non-Gotal opponents.

Poor Eyesight: Gastess' bad eyesight gives him -1D to *search* and visual-based *Perception* checks.

Force Points: 1

Character Points: 3

Move: 10

Equipment: blaster pistol (4D damage), usually displayed prominently on his right hip, 2,000 credits, datapad

Capsule: Sarlim Gastess is a thoroughly unpleasant individual. Ill-mannered, bullying, and brash, he is accustomed to getting what he wants, no matter how many innocents he has to step on to get it. In fact, his favorite part of being in business is the destruction (both figuratively and literally) of his opponents. His eyesight is poor, but he makes up for his physical shortcomings by his overbearing and iron-fisted control of his company, and by dominating his subordinates as much as possible.



her ("Welcome to Margath's. I am the owner, Kina Margath."). It would be difficult to imagine her wearing untidy clothes, and even if she did, she'd still manage to look timelessly elegant in them.

Kina Margath is a professional businesswoman of the highest calibre. She has to be — five-star hotels don't run themselves. Nor do casinos. Or bars. And Margath's on Elshandruu Pica, Quence Sector, is all of these.

Margath's has over 1,500 full-time staff, and three times as many part-timers. And on top of *that*, she is a part-time Rebel agent. Margath has been running her business empire for over fourteen years now (ever since she inherited it from her parents) and she has built it up into a company with a galaxy-wide reputation ("Yes, we have conference facilities, private gaming rooms, communications facilities — Elshandruu Pica is a sector capital — droid services, a gymnasium, zero-g swimming and gravball, and if you require anything else, you need only ask. The main desk is open 26 hours a day.").

Soft-spoken, with quiet authority, Kina Margath

Margath's on Elshandruu Pica The 27th Hour Social Club

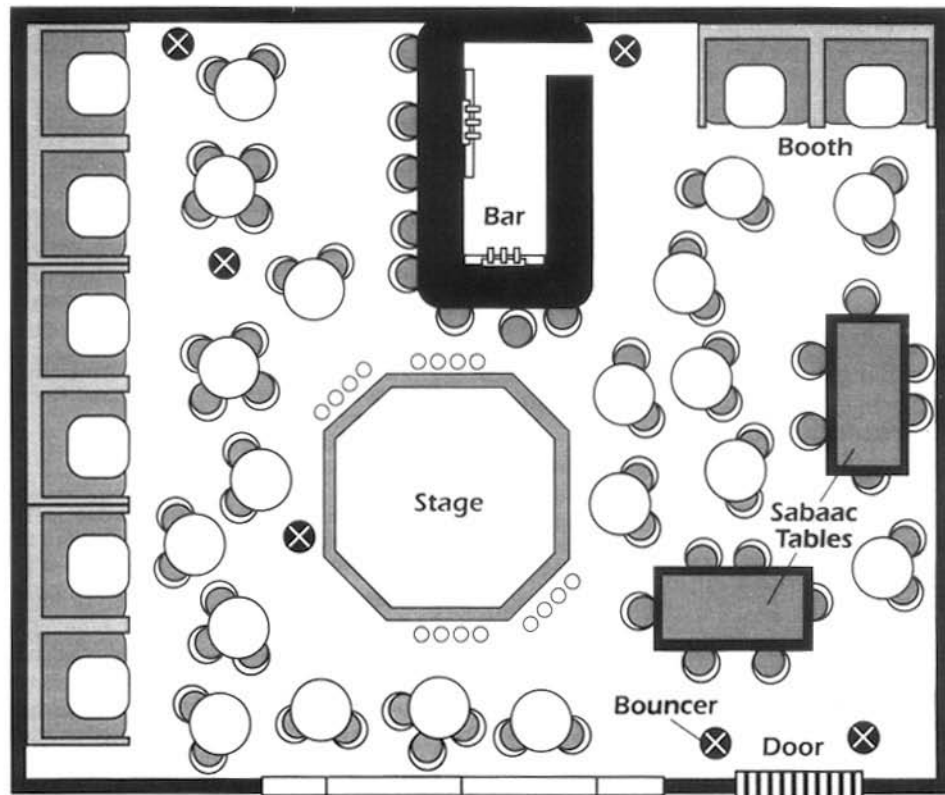

Kina Margath

Type: Successful Executive

DEXTERITY 3D

Blaster 4D+1, dodge 3D+1

KNOWLEDGE 3D

Alien species 4D+1, bureaucracy 4D+2, business 7D+1, cultures 5D+1, languages 5D+1, streetwise 6D

MECHANICAL 2D+2

PERCEPTION 4D

Bargain 8D+2, command 6D, con 4D+2, gambling 6D

STRENGTH 2D+2

Stamina 3D

TECHNICAL 2D+2

Computer programming/repair 4D, security 3D

Force Points: 1

Character Points: 12

Equipment: Forgery kit, selection of fake IDs, 3 Cybot Galactica 3P0 protocol droids, 2 Cybot Galactica XC2 administration droids, hold-out blaster (3D damage), between 5,000-12,000 credits.

is a born leader. She quietly despises the Empire for its trade restrictions and prohibitionist nature, and she takes satisfaction in letting Rebel agents use her places as safehouses as long as their presence doesn't bring unwanted Imperial attention.

The 27th Hour Social Club

"The 27th Hour Social Club" is *the* place to go in the Margath's on Elshandruu Pica complex. While Margath's has scores of clubs catering to every taste from the travelling business person to the bored young adult, "the 27th" is a club where you can meet people of every kind: spacers, business persons, exotic entertainers, smugglers and gun runners, criminals, musician groupies, musicians, stock traders, used droid salespeople, and anyone else who might have cause to travel to or vacation at Margath's (which means just about anyone). Everyone parties here on equal ground and with equal fervor. The club's name derives from the fact that it never seems to have less than 150 patrons, much less never closes: the place literally parties 27 hours a day

(not bad for a planet with a 26-hour day)!

This club is also where Kina Margath chooses to spend most of her free time: the diversity of people, attitudes and behaviors gets the adrenaline pumping and she loves to see people having a good time. The appeal of the 27th is obvious: as it sits at the head of the Margath's complex, it is the first establishment that visiting patrons check out. In time, this tradition became established, and soon people selected the 27th as a regular meeting place. Eventually, habit became an ingrained tradition for just about anyone on Margath's — and the rest is history. As a result, the waiting line to get in to the 27th can be several hours on busy holiday nights.

The 27th is equipped with an impressive holo, laser, sound and subliminal system: entertainment ranges from live bands (including *Deeply Religious* in disguise), to music cartridges, to

stand-up comics; the holos, lasers and vidscreens that accompany such shows range from the mildly entertaining to the outrageous (*Deeply Religious'* frighteningly realistic holographic Rancor tromping across the bar was the talk of Margath's for months).

Drink prices at the 27th are a little on the pricy side, but the entrance has a sign posting a challenge to all celebrants: "If we don't know it, your tab is on the house!" While that pledge has cost Kina Margath thousands of credits over the years, it has also given the bar a drink library of over 14 million concoctions. It has also encouraged customer loyalty: travellers with new drink recipes from the far reaches of the galaxy come here first in the hopes of getting a free tab for an evening, and being able to stump the bartenders has become as traditional as getting a holo of the Torch Nebula from Shownar.

Chapter Five

Guilds

Guilds have a special place in the *Star Wars* universe. They are composed of individuals and corporations that are engaged in similar fields of trade, and therefore lobby for things that are good for the industry, but every individual member of a guild is competing with all of his or her fellow guild members.

Some of the guilds introduced below wield immense power and influence in the Outer Rim Territories or appeal to sensibilities of certain player character types. Other guilds might be able to provide unique and highly specialized skills for characters in need.

The Most Honourable Guild of Armourers

The Most Honourable Guild of Armourers consists of the best the galaxy has to offer in terms of weapons specialists. The Guild specializes in extremely exotic and rare weaponry. While they do sell standard items such as BlasTech DL-18 blaster pistols, they don't make a huge profit from it. The Guild's main focus is rare, expensive and sometimes restricted weaponry.

The Guild has found a unique system for avoiding "Imperial entanglements." Simply, the Guild has resources so vast that it has purchased the planet Epsi Nadir, where its auction house is located. The Guild then obtains planetary waivers, which are perfectly legal and binding, to sell its wares. Most of these weapons are classified as "collector's items" or "historical artifacts" to avoid unnecessary bureaucratic wrangling on other worlds. The Guild's customers are expected to register their "collector's" weapons, especially the *really* illegal ones, but for a small, under-the-table fee, the documents are often "lost."

The Guild has franchise deals with every major arms manufacturer in the galaxy and contacts with almost every minor company. The range of weapons covers everything from common blasters to stokhli spray sticks to ancient weapons no longer in common usage, such as rail guns and micro-missile guns. If the Guild doesn't sell it,

either it isn't made anymore, or it's unknown technology (in which case, the Guild *will* find it, once its members are aware of its existence).

Of course, items occasionally surface that ought to fit into one of those two categories. Recent Guild auctions have had a lightsaber, a partial suit of Mandalorian battle armor, and an assassin droid among the lots on offer. These weapons and objects go for extremely high prices during open auctions. Even though the bidding for the saber exceeded 250,000 credits, it apparently didn't reach its reserve.

The main Guildhouse is situated deep in the Core, which makes going there very dangerous for any character with any reasonable amount of experience (as he will usually have a bounty to match). Conversely, few characters without this experience will have the money needed to make the trip worthwhile. It is therefore fortunate that once a year the Guild loads a liner with a large number of trade "samples," and heads out to the periphery of the galaxy. Simultaneously, it sends out a large number of invitations to some of the richer individuals who might be interested in the Guild's products.

Past Guild customers have included Boba Fett, Dengar, Zardra, Matt Talon, and many other bounty hunters with similar reputations, as well as many crimelords, wealthy recluses, Imperial and planetary nobles, and corporate executives who find it *convenient* to be able to buy weapons on the cutting edge of galactic technology in a location where no one asks awkward questions. Some of these individuals have exotic and demanding requirements which simply cannot be met elsewhere.

For instance, Marshal Levnis, a planetary baron, has for a long time been trying to find a *Kalld'n*-class stardrive for his personal yacht, the *Lady Akiko*. Seeing as only fifty of these drives were built, and forty-three have been accounted for, the Guild really is his last hope. The Moff Balfour is in a similar position. Eventually, if it is available, the Guild will find what is required.



Then there are the likes of Count Imal Valesovich or the High Lord Affric of Sarin Sector, both duellists of the old school and *always* looking for this or that ancient duelling sword or vibroblade to add to their collections.

Getting a Guild Invitation to attend the annual Auction is often an adventure in itself. Make no mistake: if you aren't invited, the Guild doesn't want you there. However, with the right bribes to the right planetary officials, arrangements to attend can be made.

Other possible scenarios involving the Guild could include an actual auction on Epsi Nadir. Attending an auction is *always* going to be interesting if the characters have the nerve to stay in the same room as Boba Fett, IG-88, Zardra and goodness knows who else for more than five seconds. The Guild Auction Hall is probably the most dangerous place in the galaxy to start a fire fight ...

Another option is to have the Guild commission the characters (if they are well-enough known in the right circles) to obtain an item of some kind for them.

Corellian Merchants' Guild

The Corellian Merchants' Guild (CMG) is one of the largest private trade organizations in the galaxy. Membership is open to all native-born Corellians, and all owners or crew members of Corellian ships. In fact, some companies install a Corellian as their CEO in order to gain member-

ship in the CMG.

The Empire deeply mistrusts this organization, viewing it as a veritable hive of anti-Imperial activity, law-breaking and sedition. They're right, but only on the Guild's *good* days. Unfortunately, the Guild has such a stranglehold on galactic commerce the Empire doesn't dare to shut it down. Because of the way the Guild has been set up, individual Guildhouses are completely autonomous. Even under Imperial law, the Empire can only shut down one Guildhouse at a time unless it passes a law to make the entire organization illegal in the same way that the Rebel Alliance is illegal. The economic consequences of such an action would be dire, and so, as things stand, whenever one Guildhouse is closed down for anti-Imperial activity, another one immediately pops up to replace it. Corellians are always liked dropping grit into the bureaucratic machinery of authority, and the Empire is certainly a worthwhile target.

On a day-to-day basis, the Guild provides trade contacts and information for its members, starship repair bays, refits, repairs, upgrades, restock and supply, Corellian whisky and also a sort of "help service" for beleaguered traders. The trader must lodge a sum of money (from 100 to 10,000 credits, 1,000 being the average sum deposited) with the Guild, and this is then recorded as Guild credit. From then on, as long as any of this money remains, the Guild will provide



■ A celebration at a CMG Guildhouse is not for the timid...

legal aid, “backup finance” (i.e., some of the Guild credit is returned without charge), and any other resources that the trader may need to get him out of a predicament. The more credit you have lodged with the Guild, the more help you will get.

Starship services are all provided at standard prices to Guild members regardless of their price locally. This can be a boon in some systems, where charges are double and triple the standard rate, but unfortunately not all planets have a CMG Guildhouse on them.

There is also a free message service for Guild members: leave a message with one Guildhouse, and whenever a Guild member happens to be heading in the right direction, he’ll pass the message on for you. This is a rather erratic means of message transmission, and it is much faster for planets that are frequently visited by Guild members, but since the dismantling of the HoloNet, it compares favorably with using courier vessels or the Imperial Data Service (which is by no means secure or free from prying eyes).

This message service might provide some useful scenario hooks: a character might be asked to carry a message to an out-of-the-way planet because it’s less of a detour for him than for anyone else, or he may receive a message from an old trader friend who needs his help.

The Guild’s willingness to help out its members whenever possible might also hook the characters into a scenario, or they may even need to make use of Guild facilities themselves.

Zygerian Slavers

Under the Old Republic, slavery was outlawed and abhorred by all respectable beings. The Republic strove to uphold the rights of all sapients. However, with the rise of the Empire and Imperial Decree A-SL-4557.607.232, which legalized procurement of slaves under certain conditions, this horrible practice has returned to the galaxy. The formerly secret Guild of Zygerian Slavers went public shortly after slavery was made legal; as the Empire’s oppression has spread, so the Zygerian Slavers have come into their own.

The Zygerians’ success as slavers is due, in large part, to their generally disciplined approach to the business. Individual slavers pay a yearly membership fee to join their guild system, and are then allocated a “patch” of space in which to work. These patches vary in size, from portions of planets on highly urbanized worlds, to whole planets, to entire systems, depending on the level of membership the slaver pays for. The more ready cash up front, the larger the patch.

There is a guarantee that only two or three other slavers will have been allocated the same patch, ensuring that all parties can operate profitably. If any other unaffiliated slavers try to

muscle in on this area, the guild may also be able to provide sufficient backup to dissuade them, although this is not always the case.

The guild structure also allows the Zygerians to obtain Slaver Permits from the Empire at reduced prices. Since the Empire has legalized slavery in some regions, there is now a thriving trade in slaves. The discipline of the Zygerian approach also means that the Twi’leks of the Ryloth system tend to use Zygerians in preference to other slavers, as the Zygerians’ “honorable” approach to business reduces the damage the slaving does to Twi’lek society.

Lantillian Spacers’ Brotherhood

This guild is often regarded as a sort of second-rate Corellian Merchants’ Guild. Membership is open to any spacer (Corellian or not, regardless of species or sex; a surprisingly enlightened attitude in light of the Emperor’s anti-alien bias). The Brotherhood provides trade contacts and information, starship repair and upgrades, and restocking and supply facilities (usually at 90% of the going rate on the planet concerned). The Brotherhood does not provide the message or finance services that the CMG does, and its guildhouses are not as frequently encountered. Generally speaking, anyone who qualifies for CMG membership joins the CMG; significantly fewer traders choose to join the Brotherhood.

The Lantillian Spacers’ Brotherhood has another problem, too, in that because it lacks the CMG’s economic clout, it is more vulnerable to Imperial harassment. Consequently its guildhouses have to be somewhat more law-abiding. This probably also adversely affects guild membership figures, given the leanings of most of the small traders who might be interested in joining.

Ithorian Trade Guilds

“Never pass up an opportunity to trade with an Ithorian. You’ll get high-quality goods, and unless you really let him gouge you, you’ll get a fair price. There’s always a market for Ithorian produce, too.”

— The Spacer’s Handbook (Bootleg Edition)

Sound advice. One of the factors behind the good prices that can be obtained is that Ithorians are almost invariably the producers of whatever they sell: foodstuffs, grains, seeds, and so on. As a result, they can sell at very low prices and still make a healthy profit. That profit usually gets reinvested in the Ithorians’ business, making it more efficient and able to sell profitably at even lower prices.

Traders with reasonable *bargain* skills can often buy goods wholesale at 5-10% below the market rate and make a healthy profit for themselves at the other end. Meanwhile, the Ithorians,



for whom growing things is not merely a job, but a religious obligation, are happy to have plenty of cash coming in to let them expand their planting operations. In fact, on some of the poorer worlds where Ithorian trade centers have grown up, the Ithorians are happy to give their produce away to the impoverished local residents. The Ithorians have also pioneered several crop education programs for local produce growers so that these poor and uneducated planets can feed themselves.

Ithorian Trade Guilds are a pleasure to visit and are much more convenient than hoping to come across a Herd Ship. Specific Guild trade centers are generally owned by specific Ithorian Herd Ships, and are usually good size complexes. They are often oases of green in cities where

every other trace of plant life has been obliterated in the name of profit; they are invariably packed with an astonishing variety of trees, shrubs, flowers, fruits, bulbs, grains, tubers, grasses, fungi and nuts. If you require a variety of grain that will cope with a fully arid climate, or a fruit that won't rot even if it is rained on for 350 days in a standard year, or a bulb that can complete its growing cycle in exactly 800 days, ask an Ithorian. Even if he doesn't have it, he'll cultivate one for you, often inside a few months. And what's more, if you can supply him with a variety of plant that he hasn't seen before, he might give you a little extra discount by way of thanks.

Institute of Starship Engineers

This is one of the most highly-respected engineering institutes in the galaxy save for the Imperial Engineering Academy. *All* professional starship engineers are advised to gain an accredited qualification from the ISE. The Imperial Navy, for instance, requires graduates of the Imperial Engineering Academy that enter the Navy to receive biannual certification from the ISE. Many corporate concerns take a similar standpoint. Indeed, becoming a full member of the Institute — a Chartered Starship Engineer — gives the engineer many possible avenues for career advancement, as well as many job opportunities where he can choose his own wage. There is almost a 100% uptake by those people who qualify.

Members of the ISE are quick to point out that they are *not* starship mechanics; rather they are engineers, concerned with the functioning of the vessel as a whole rather than a specific system or sub-system in particular. They supervise the activities of the various technicians, mechanics and droids that are needed to run a starship.

The Institute has a huge campus located on Coruscant, and has branch campuses in the Corellian System, Sullust, and Perithal VI. The ISE used to have a campus on Alderaan. The cost of entering the ISE is fairly high, with a charge of 15,000 Imperial credits per semester. Students undergo grueling, hands-on courses in hyper-space engine repair for space transports and capital ships, astrogation, computer programming and repair, and capital ship gunnery repair (among others). As students complete these rudimentary courses, they begin learning the art of engineering starships, from major overhauls, to designing new ships from scratch. The majority of the students attending the Institute are receiving post-academy training in accordance with Imperial Navy requirements. Many students have been able to sell their designs to starship manufacturing companies.

Chapter Six

Bounty Hunters

Given that an overwhelming number of player characters are wanted by the Empire (or by a crimelord, or by a corporation, or by *someone* who is willing to pay hard credits for their hides), characters may wonder exactly how much of a threat the bounty hunters chasing them pose.

A good rule of thumb is to consider the bounty offered as a gauge to indicate the skill of the pursuing bounty hunters. The higher the bounty offered, the tougher the bounty hunters chasing the characters are going to be (Boba Fett doesn't chase people until it's *worth* his time).

Most average bounty hunters will take the time to chase a character with a bounty of 1,000 credits or less. Bounties of 1,000 to 5,000 credits attract novices and average bounty hunters. Bounties of 5,000 to 20,000 credits attract veteran bounty hunters or superior quality bounty hunters that have fallen on hard times. Bounties over 20,000 credits are sure to attract superior quality bounty hunters, while anyone who is worth over 100,000 credits will attract master level bounty hunters like Boba Fett. See the *Gamemaster Handbook* for an explanation of the die codes relating to the terms "average," "novice," "veteran," "superior," and "master."

The Hundred Club

The "Hundred Club" has a particularly elevated place on the Empire's priority list. It consists of those people whose bounties exceed 100,000 credits who are still alive and free. The Hundred Club has well over 1,000,000 members. After the Hundred Club, the only way up is to get onto the Imperial "Most Wanted" list, which only has a few hundred people on it at the moment.

Bounty Postings: How They Work

Bounty hunting is still one of the most despised professions in the galaxy and bounty hunters, while technically "independent law enforcement officers," are often considered to be only slightly above the criminal scum they are hired to hunt down. Of course, with all of the criminal

activities, loan defaulters and rebellious operatives (both those in the Rebel Alliance and those who are independent traitors), there is an immense amount of work available. However, the Imperial bureaucracy, being what it is, isn't willing to allow a business worth billions of credits to go untaxed. The Imperial posting system is a way of generating the desired revenues.

In order to work "legally," a bounty hunter must obtain Imperial Peace-Keeping Certification (IPKC) — the so-called "Bounty Hunter's License." This license is valid in carefully designated areas of the galaxy (normally well away from the Core Worlds), but on its own does little more than give the bounty hunter the right to transport his weapons and equipment across the galaxy without too much harassment from the Imperials. This permit costs 500 credits for a standard year.

In order to bring in a bounty, a hunter must get a separate permit for a specific individual, called a Target Permit. In fact, bounty hunters may need *additional* permits on specific planets or for corporate areas. Some common additional permits required are usually Sector Permits (valid throughout one sector or oversector for a specified time, and good for *any* individuals or a specific individual, depending on the permit), a System Permit (valid in a single star system for a specified time, and also good for a lone or any number of individuals, depending on the permit), or the Capture Permit, which is issued after a target has been captured.

The costs of these permits vary greatly; a System Permit costs 50 to 500 credits per month (often the most cost-effective way of bounty hunting, but not all systems issue them). A Sector or Oversector Permit costs 1,000 to 10,000 credits per month. A Target Permit costs 10 to 1,000 credits per month, depending on the size of the person's bounty (unless the quarry has a very high or very low bounty, a Target Permit will cost around 100 credits). Capture Permits, since they are issued "after the fact," cost 25% of the bounty

or 500 credits, whichever is higher. "Most Wanted" bounties are posted galaxy-wide, and a bounty hunter needs only an IPKC to pursue one of these.

This system often provides a reimbursement clause built-in to these permits, allowing for any damage done on the way to be paid for out of the final bounty. In practice, only parties with a good degree of legal clout, such as Imperials, corporations and wealthy individuals, have much chance of being reimbursed for any damages suffered.

It may seem unusual to suggest that bounty hunters like Boba Fett would bother with securing permits, but it is a fact that this is the cost of doing this type of business in the Empire. For the bounty hunter, though, the profits to be made are worth the permits, and many of the more experienced bounty hunters have hired expeditors whose job is to secure the proper permits, do the proper explaining to the authorities for any "minor offenses" and to, when necessary, arrange the appropriate bribes for especially "sensitive" situations.

Private Postings

Needless to say, Imperials aren't the only people to post bounties. Crimelords, corporations and private individuals also post bounties (Jabba the Hutt is notorious for this). *Legal* private bounty postings must be lodged with the Empire (for a fee, of course).

The fee depends on the area in which the bounty is to be posted. For example, a sector or oversector posting costs 1,000 to 10,000 credits; a system posting costs 50 to 500 credits. Private concerns may not place "Most Wanted" notifications. In addition, the full quantity of the bounty must be pre-paid to the Imperial Office of Criminal Investigations (IOCI). Bounty postings may also be placed through local governments from town to planetary level, although legal restrictions and associated fees vary immensely from locality to locality. While specific local laws may vary and there are exceptions in the Imperial legal code, in general, a bounty may only be posted against individuals who, in the Empire's opinion, have conclusive evidence of illegal activities against them.

Some companies post bounties through the Empire, though many do not. Corporate bounties function in a very similar manner to Imperial bounties, save that they are posted by companies and the issued permits for that bounty are only valid within that company's territory. Some corporations charge very high permit fees, and others waive the costs entirely. Some companies generate substantial revenues by posting false bounties and then gathering permit fees from inexperienced bounty hunters. The legal code that the bounty hunter must operate under var-

ies from company to company, and while these laws are the final authority within that company's territory, outside of company territory, the local or Imperial law is the final authority.

There are also several posting agencies which serve as an intermediary between the Imperial government and the private concerns who want to post a bounty. The majority of agency postings come from individuals or companies who have a small number of postings in a year — people with many postings deal with the government directly, while people who will only post one or two bounties in their entire lives often handle the matter privately. The agency is responsible for checking evidence, making postings available to bounty hunters, collecting appropriate permit fees and then passing the appropriate share to the government. The Empire often accepts a lower percentage because the volume of revenue generated by most agencies is *quite* impressive. Bounty hunters prefer to work with agencies because it is just one more step removed from the government and overly curious inspectors; corporations like the agencies for the same reason and also for the reduced bureaucracy involved with the posting; and, the Empire likes the agency approach because it gets huge revenues for minimal effort. Of course, some agencies are less scrupulous than others and may handle postings with questionable evidence or none at all, especially since Imperial investigators are often willing to accept bribes to avoid specific cases.

Illegal Postings

Crimelords, for obvious reasons, seldom *publicly* post bounties. Posting a private bounty without notifying the IOCI is a criminal offense (Class II or III infraction under Public Order Act 96.76, the Assault and Injuries Act (rev. 96.82) or the Mandatory Notifications Ordinance #885.774.283 Sections B-E).

Bounty postings by crimelords are the simplest of all. Simply kill or capture the individual, bring whatever is left to the crimelord's home planet, and you will usually be paid cash in hand. Some crimelords, notably Ploovo Two-for-One, pay commission for any funds or valuables that the bounty hunter is able to retrieve. A common rate is 10% of the value of all retrieved items.

Of course, private postings are a way for criminals to get troublesome people out of the way and a way for the bounty hunter to get a little extra money on the side without paying for permits. Some companies, guilds, and in rare cases, even Imperial officials or nobles, have been known to privately post bounties in situations where they feel that they can't get appropriate satisfaction through normal legal channels.

Individuals who are well-connected with the

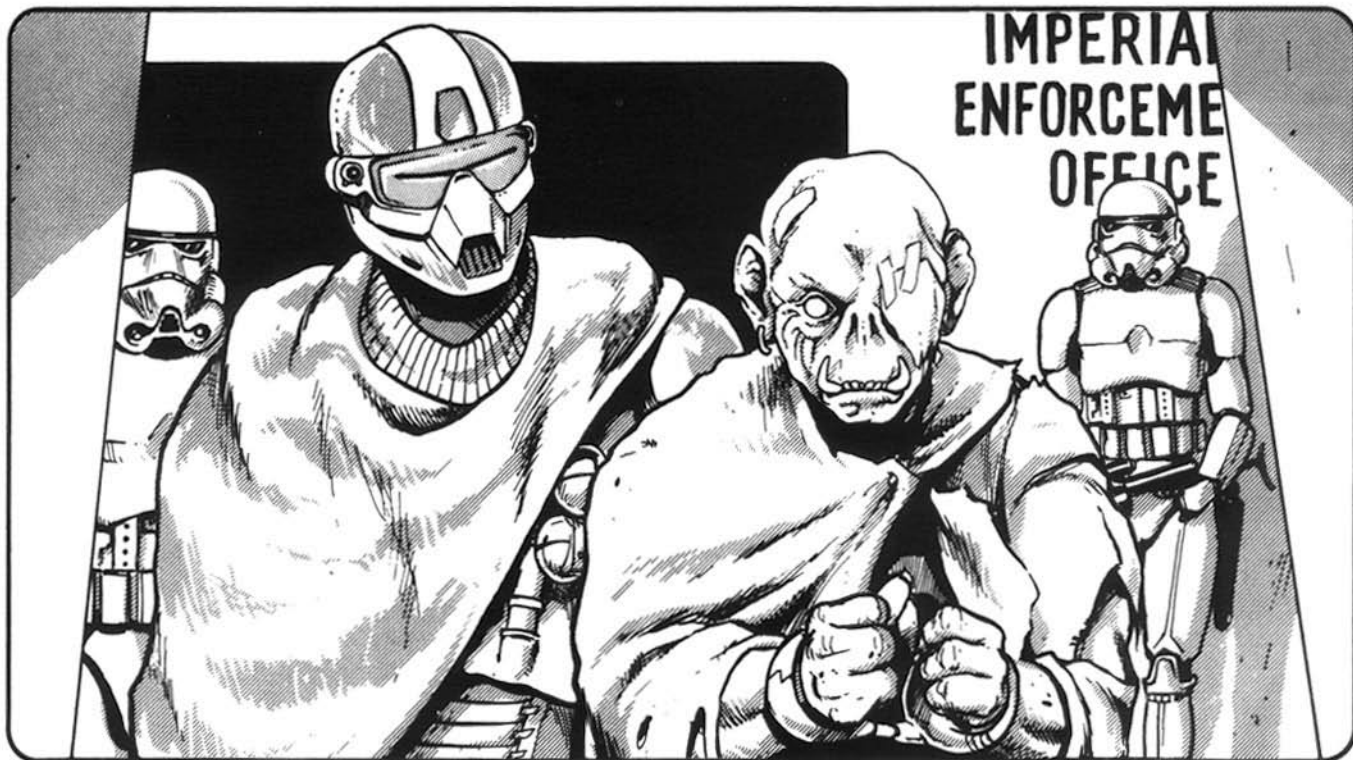

Empire or local governments may be able to get around certain “bureaucratic missteps,” such as a lack of the proper permits.

Pin Money

“Pin money” is the term used by Zardra and some other bounty hunters to describe those small-time criminals who have been engaged in illegal activities over an extended period of time, but who have still only managed to amass a very small bounty. The hunters use the bounties on these individuals as a sort of free-floating supply of petty cash to cover the expenses of hunting more worthwhile prey. Other terms commonly used to describe these targets are “loose change,” “petty cash,” “pocket money,” “disposable income,” and so on.

A prime example of a criminal to whom this term applies is the outlaw Helm Iskraker, described in the adventure *Crisis on Cloud City*. Most “pin money” targets have bounties of several hundred credits, perhaps one or two thousand credits at most. Their defining feature is that these people have stumbled through ten, twenty, thirty and more years of bungled thefts, murders and assaults, and still haven’t managed to amass a “worthwhile” bounty.

Bounty Hunter Syndicates

Only the very best big-league bounty hunters find the risks of working alone offset by the profits to be gained. Most beginning and inexpe-

rienced bounty hunters usually find that they are better off operating as part of an organized syndicate. This type of set-up has a number of advantages, not least being the fact that some money is still coming in when business is slow and the syndicates teach new bounty hunters the ropes without getting them killed (usually).

A typical arrangement is to have a central office located near a number of profitable systems, a couple of administrative staff (often a droid or two), some medical facilities, and perhaps a data link to the *Imperial Enforcement DataCore*, where the main bounties are posted. Major syndicates are often sited at sector capitals, where the faster communications of the capital can be put to good use. Syndicates also

Ad Hoc Syndicates

Not all bounty hunter syndicates are permanent affairs. Occasionally a group of hunters who may or may not have worked together before join forces in order to collect a specific bounty. Imagine a syndicate composed of IG-88, Dengar, and six others of similar skill coming for you. These groups, if they work well, may occasionally give rise to a new syndicate. If not, the bounties collected will be shared among the survivors, and the hunters will go their separate ways once more (peaceably or otherwise).



■ Some believe that only crimelords call upon bounty hunters, but even the most respectable Imperial officials need a job done discreetly...

spring up at the sites of local “hot spots” so that a faster turnaround time can be gained.

The numbers in a syndicate vary a great deal; there might be three or four hunters in the smallest ones (for instance, some of the groups in the adventure *Tatooine Manhunt*), while the larger syndicates (such as the Mantis Syndicate on Santarine) muddy the border between syndicates and mercenary companies.

Suffice it to say that if you get a single bounty hunter after you, that may be regarded as unfortunate, but if you can shake him off he will probably take the hint and go and pick on an easier target. However, if you attract the attentions of a good syndicate, you have about the same long-term survival chance as a Rancor hunter armed with a toothpick.

The Ragnar Syndicate

The Ragnar Syndicate is based in Ragnar system, Merel Sector. It is one of the biggest, most professional bounty hunter syndicates in the Outer Rim Territories and is slowly gaining ground on the more established galaxy-wide syndicates. The group has several master bounty hunters at its disposal, probably ten times as many veterans, and countless novices. The syndicate is large enough to give pause to the best Special Ops groups, never mind anyone else. In the sectors where the group most commonly operates, namely Merel, Astal, Dail, Skine, Lol, and Portmoak (on occasion), those on the sidelines usually consider the results to be a foregone conclusion. (“You’ve got the Ragnar Syndicate after you, boy? Hurr. Hurr. Hurr. Have you made yer funeral arrangements yet? If not, yer too late. Hurr. Hurr.” They’re almost always right.)

The syndicate usually works in groups of four to ten hunters, and wherever possible, unit leaders are required to choose one or two novice hunters from the group training pool to be included in their mission detail. The novices chosen will be ones who are good enough to cope with the hazards anticipated, but who will learn from the experience. The rest of the group will be made up of more experienced members. Aside from standard bounty hunting, the Ragnar Syndicate often takes contracts involving siege-breaking, anti-terrorist operations, sabotage, assault, and other quasi-mercenary activities. Where additional firepower is necessary, the syndicate has sufficient finances to augment its numbers by hiring a mercenary company or two. The group has not yet been hired for a battalion-level operation, for which everyone else ought to be thankful.

Syndicate members are engaged on short-term contracts — that is, for the duration of one specific mission. This allows the more experienced members to continue with their own freelance work. Advancement within the syndicate is strictly on merit, and it typically takes about five years for the better candidates to advance to second-in-command level for missions. From second-in-command, it generally takes about another three years for a hunter to gain sufficient command experience to lead of a team of his own. The syndicate doesn’t have to worry about an over-abundance of potential officers. Novice bounty hunters have fairly low pay levels (not nearly as much as one *could* make freelancing). The money that the syndicate saves by paying lower wages is used to train “syndicate loyal” and experienced hunters, as well as for the syndicate’s new equipment and maintenance costs.

The Ragnar Syndicate's home sector, Merel, is ruled by Moff Tregar. Moff Tregar is an extremely competent individual (he was reckoned to be too influential to be made into a Grand Moff), and he and the Ragnar Syndicate have what has been described as "a good working relationship." This bodes ill for many Rebel units; Tregar often uses the Ragnar Syndicate for missions that could cause "embarrassment" if undertaken by the Imperial military. The Ragnar Syndicate invariably fulfils its side of these contracts admirably.

The Mantis Syndicate

The Mantis Syndicate, based in the Santarine system in the Hook Nebula, is another extremely rich and powerful bounty hunter syndicate. This group is even bigger than the Ragnar Syndicate, but it concentrates on larger-scale missions. The Mantis Syndicate *has* been engaged in battalion-level operations. Most of the group is currently being held on retainer by the High Lord Affric of Sarin Sector, who appears to be using the unit as his own private army. That means that the unit can currently "only" muster sufficient forces for company-level objectives elsewhere.

Generally speaking, the group operates mainly against pirate groups, swoop gangs, outlawed mercenary units, and similar organizations, such as the Nova Demons (described in *Planets of the Galaxy Volume One*). Fortunately for the Nova Demons, they are some way outside the syndicate's accustomed sphere of operations, but in the last two years, three swoop gangs and four mercenary units have not been so fortunate. The group also recently wiped out a group of unlicensed slavers operating out of the Suhurmin system.

The Slaver Syndicate

This is another large bounty hunter syndicate which recently moved to a new base in one of the Karazak system cave complexes. Karazak is one of the slave capitals of the Outer Rim Territories, along with Zygeria and the Thalassian system. Rather than being a cross between a bounty hunter syndicate and a mercenary unit, this group captures some of the less-wanted fugitives, collects their bounties, but then instead of handing them over to the Imperials for imprisonment, the group buys the ownership rights to its captives, and sells them off as slaves. Many alien species, notably Agorffi, Gamorreans and Wookiees, are particularly prized for their brawn and usefulness in hard labor situations.

The Skine Bounty Hunter College

This is a somewhat smaller syndicate. It is a specialist group, dealing almost entirely with so-called "vagrant" fugitives: those who evade capture by keeping on the move across the galaxy, usually because they have their own starship. The syndicate specializes in cold trails and tenuous leads, and has a success rate of more than twice the average figure for the industry. It also takes a lot of trouble to collect *all* of the extant bounties on its prey — a thousand here, two thousand there — after all, it soon adds up.

For an exorbitant fee (100,000 credits and up), the College will trace anyone you ask it to provided they have been sighted at least once in the last fifteen standard years. All members of the College typically have *search* and *investigation* and related skills at 7D and higher. The College is actually a widespread net of hunters and informants, covering much of the galaxy, though it is quite popular in the Outer Rim Territories, Wild Space, and the Unknown Regions, since those regions are easy to disappear in. The College won't give up until every last lead has been chased down to a dead end, even in these remote regions.

Guild of Hunters

The Guild of Hunters is *the* bounty hunters' club. Unfortunately, it is so secretive that no one knows much about it. This select group of the galaxy's most deadly and bloodthirsty bounty hunters offers the rich and powerful the solutions to any "problems" they may have with another person. It is rumored that no one has contacted the Guild; if a bounty worth the Guild's time is made known, someone from the Guild will contact you. They are a frightening bunch.

The Guild of Hunters will hunt anyone (for the right price, which is invariably obscenely high), and kill or capture to order. They have several assassin droids available, and they can call on some of the best bounty hunters in the galaxy. All of this is reflected in the amounts they charge. However, *for one year only*, Core World assassinations are on *special offer*. Yes, that's right, for a cool one million credits, they'll kill any Core World resident outside of Imperial City and the top Imperial bureaucracy, with no questions asked. Inside Imperial City? Nothing doing. One of their best customers lives there ...

Chapter Seven Military Units

Aside from the forces of the Imperial military, there are many independent mercenary units that are available for hire in the galaxy. This is because the forces of the Empire cannot be everywhere to enforce order; independent corporations, planetary governments and fabulously wealthy private citizens often hire mercenary units for self-defense, and in some cases, to settle long-running disputes. The publicly known mercenary units, of necessity, only take part in legal missions, such as defense from pirates and to suppress rebellion on a world. However, many units, especially underground mercenary armies, do quietly take missions that skirt the limits of or even flagrantly violate Imperial law.

The First Sun Mobile Regiment

The First Sun Mobile Regiment is a mercenary unit that contracts out to the Imperial Army quite frequently. The First Sun is a repulsorlift infantry regiment designed primarily to run search-and-destroy missions, which the troops of the unit jocularly refer to as SLAMs (Search, Locate, Annihilate Mission). Indeed, the regiment often undertakes missions with the same objective as the Empire's "Base Delta Zero" command: the elimination of all assets of production, including factories, arable land, mines, fisheries, droids and sapient beings (particularly any witnesses that may have seen atrocities being committed). Within the limits of their resources, the First Sun have proved completely reliable at achieving this self-imposed objective. Naturally, they have gained a reputation for total ruthlessness and are rumored to be responsible for some of the more heinous atrocities so far committed during the war.

Generally speaking, the First Sun Mobile Regiment works for the Empire on worlds where it is not cost-effective to use regular army troops or where the local military is not "sufficient to enforce loyalty to the New Order." Recently, how-

ever, there was one occasion where an Imperial Moff had his personal stormtrooper guard butcher one of the First Sun's companies after they "exceeded their authority" by exterminating an entire outpost before Imperial Intelligence had an opportunity to interrogate the inhabitants.

Since then, the First Sun has tried to keep the Imperials at arm's length. While publicly the First Sun is still totally committed to the Empire — after all, there are too few other organizations with enough ready cash to hire an entire *regiment* — the Mobile troops don't trust the Imperials any more and they make absolutely certain that they do not have to rely on Imperial backup to extricate themselves from any "tactically compromising" situations. It is believed that the leadership of the First Sun is investigating alternatives to working for the Empire, although it is doubted that joining the Rebel Alliance is considered a viable alternative.

■ First Sun Mobile: Average Trooper

DEXTERITY 3D

Blaster: blaster pistol 5D, blaster: blaster rifle 7D+2, dodge 5D, grenade 5D, melee combat 4D+2, melee parry 4D+2, vehicle blasters 6D+2

KNOWLEDGE 3D

Planetary systems 5D, streetwise 4D, survival 5D

MECHANICAL 2D+2

Ground vehicle operation 4D, hover vehicle operation 4D, repulsorlift operation 4D, walker operation 3D+2

PERCEPTION 3D

Hide 5D, search 7D+2, sneak 5D

STRENGTH 3D

Stamina 5D

TECHNICAL 3D

Computer programming/repair 4D, demolition 6D, first aid 4D, security 4D

Character Points: Varies, normally 0-5

Move: 10

Equipment: Comlink, datapad, glowrod, macrobinoculars, 2 medpacs, survival kit (tempshelter, long-range comlink, rations for mission duration, medicines, molecord rope, magnetic grapplers), BlasTech EKK-10 blaster rifle (5D damage), Merr-Sonn Munitions DD6 blaster pistol (4D+1 damage), 3 fragmentation grenades (5D damage), blast helmet (+1D to head front and back physical attacks; -1 from energy), blast vest (+1D to torso front and back from physical attacks; +1 from energy)



Churhee's Riflemen

Churhee's Riflemen, named after its now-deceased founder, Vlaydm Churhee, is another mercenary unit that specializes in "low profile" operations in the outlying systems of Imperial influence. The Riflemen are an experienced scout company currently operating in Sarin and Parmel Sectors, which contains some Imperial colony worlds and some weapons production facilities. They usually engage in rear-guard harassment of the enemy.

Churhee's Riflemen were a truly mercenary outfit, often changing sides to the one with the most currency available. On a mission for the Imperials in Y'Trella system, the Riflemen were nearly wiped out when the Imperials failed to provide them with the necessary backup (it was in this mission that Vlaydm Churhee died). They do have the consolation that information in their possession at the time could have prevented the Imperials from incurring heavy losses a few days later. Nonetheless, the Riflemen now only accept anti-Imperial contracts, preferably missions that will seriously hamper the New Order.

The unit prides itself on the high quality of marksmanship among its members. When the Riflemen are at full strength, the unit conforms to the Order of Battle of a fully augmented Imperial Scout Company (as per page 89 of the *Imperial Sourcebook*), save that all line squads in Churhee's Riflemen are actually sharpshooter squads, and

typically have 6D *blaster* skills or higher. At present, the unit is operating at 65 to 70 percent of full strength.

Because of the high caliber of troops in the company, Churhee's Riflemen have proved to be a real thorn in the sides of the local Imperials — particularly in Parmel Sector. Their presence is likely to be one of the deciding factors in Moff Tallis' decision on whether to allocate additional Fleet resources to Battlegroup Operations on Turcan III. The Riflemen would be very flattered to receive this level of attention, but it would probably make their next battle their last. Alliance Command is watching developments closely; if Tallis does decide to send part of his fleet, the Rebels will need to evacuate a major portion of their ground forces in the Turcan system. The Riflemen will naturally be offered transportation if this evacuation must be enacted.

■ Churhee's Riflemen: Average Trooper

DEXTERITY 3D

Blaster: blaster pistol 6D+2, blaster: blaster rifle 8D+2, dodge 5D, grenade 4D, melee combat 4D+2, melee parry 4D+2

KNOWLEDGE 3D

Planetary systems 5D, survival 5D

MECHANICAL 2D+2

Hover vehicle operation 4D, repulsorlift operation 4D, walker operation 3D+2

PERCEPTION 3D

Hide 5D, search 7D+2, sneak 5D

STRENGTH 3D

Stamina 5D

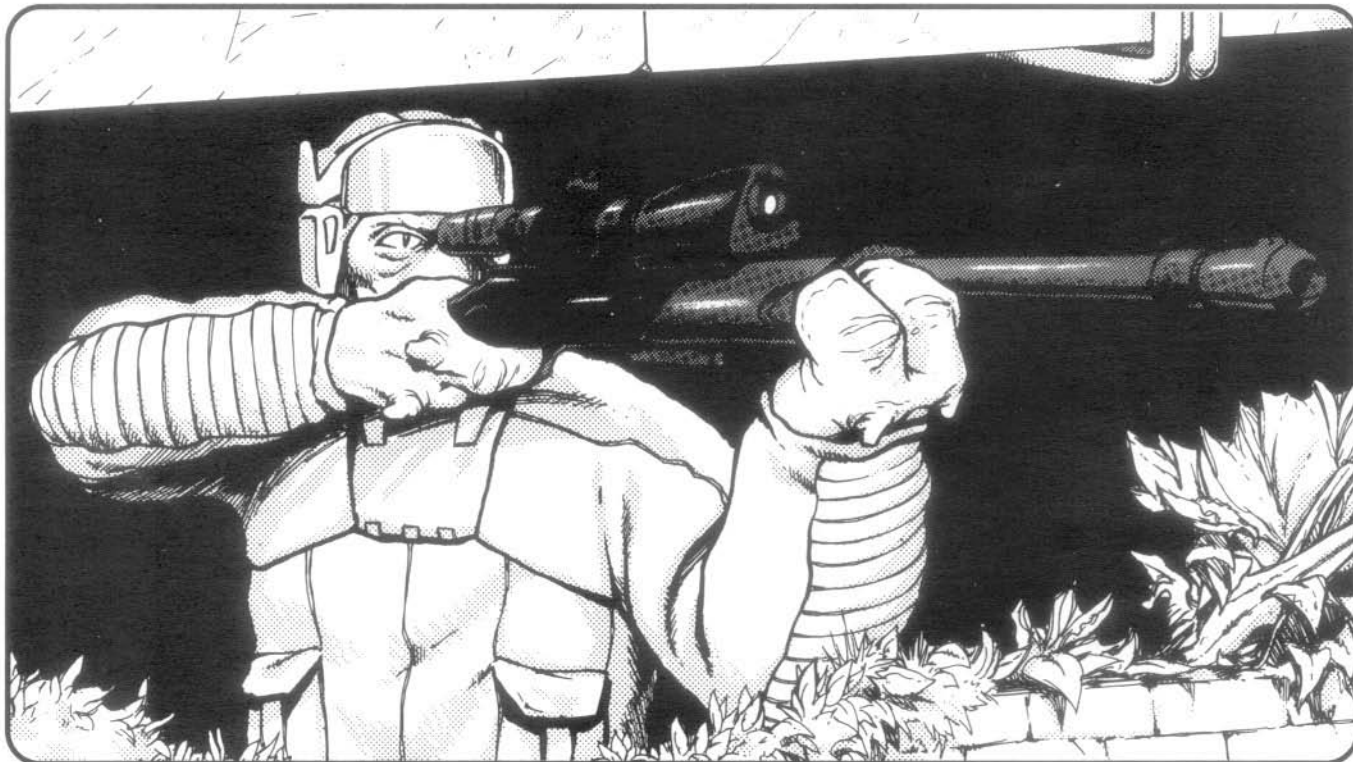
**TECHNICAL 3D**

Computer programming/repair 4D, demolition 4D, first aid 4D, security 4D

Character Points: Varies, typically 0-5

Move: 10

Equipment: Comlink, macrobinoculars, blast helmet (+1D to head front and back for physical), blast vest (+1D front and back torso for physical attacks, +1 for energy attacks), SoroSuub Model Kylan-3 heavy blaster pistol (5D+2 damage), knife (STR+1D damage), uniform, survival kit

The Laramus Base Irregulars

The Laramus Base Irregulars are a small, ragged company of quasi-Rebel soldiers, specializing in missions so dangerous that the members of the the company are known as “dead men.” The unit is currently under the command of Tagg Pierce, a former lieutenant in the Rebel Alliance who is noted for his utter contempt for line officers. The Laramus Base Irregulars used to operate from Laramus Base in Laramus system, Parmic Sector, but Rebel activity started to get a little heavy in that area and Laramus Base was eventually destroyed by Imperial reprisals.

The company is now homeless and highly mobile, searching for a new headquarters. They have travelled as far afield as Aris V in Parmel Sector during this search. At present, the unit is fragmented into sub-units, each with a couple of dozen members (two to four squads), spread over many different systems and more-or-less looking for some action that the company as a whole can get involved in. While they’re looking,

they accept any small-scale missions they happen to find.

The Irregulars have so many members with specialist skills — as befits a hand-picked elite unit — that they are very similar to a Rebel SpecForces unit. However, the company’s discipline is so lax, and its commanders so disliked by Rebel Command, that they are considered expendable. Often, the Rebel Alliance sends the Irregulars into tough situations to avoid sending in SpecForces that are deemed too valuable to waste on “suicide missions.” Despite this, the Irregulars have an incredibly high success rate, though they have been known to suffer up to 95 percent casualties.

Essentially, the Irregulars are a heavy line company (not a feature of the standard Imperial Order of Battle) consisting of six heavy infantry platoons and two heavy weapons platoons. They also have all the skills of an Imperial special missions unit available to them as a result of the broad experience of individual members. This is one of the most ragged, motley groups of warriors around. Sooner or later, one of the Irregulars’ roving groups of thrill-seekers or Alliance Command is going to turn up some work that the whole company can get involved in. When this happens, may the Force help the Imperials they’re up against.

The term “irregular” is not an exaggeration. The Laramus Base troops have varied backgrounds and experiences, and thus their skill

levels are highly variable. The guidelines below are simple "averages," and an individual's level of skill can be very different.

■ **Laramus Base Irregulars:**

Average Trooper

DEXTERITY 3D

Blaster 7D+1, dodge 5D

KNOWLEDGE 3D

Intimidation 6D, planetary systems 5D

MECHANICAL 4D

Space transports 6D, starfighter piloting 5D+1

PERCEPTION 3D

Hide 6D, search 6D, sneak 7D

STRENGTH 3D

Brawling 6D

TECHNICAL 3D

Force Points: Varies, but typically 0-3

Character Points: Varies, but typically 2-15

Move: 10

Equipment: Varies from mission to mission. Most soldiers are equipped with a heavy blaster pistol (5D damage) and little else. New supplies are scavenged from targets or hijacked from Imperial convoys.

Ailon Nova Guard

The Nova Guard of the Ailon system have a reputation for martial prowess on a par with the Imperial Royal Guard and the Mandalorians. For a Nova Guard, training for combat is an act of religious devotion, and is also part of a martial tradition stretching back more than 13,000 years. Indeed, the battle honors of the Ailon regiments are so numerous that only on the most prestigious ceremonial occasions are they all brought out.

In these cases, the Ailon First Honors Platoon carries the regimental honors. Every Honors Platoon Guardsman carries one banner, and every banner has up to thirty honors displayed, at a rate of one honor for each battle the regiment has been involved in. By anyone's standards, that's a tremendous amount of martial tradition.

The Ailon people are firm believers in survival of the fittest and rule by strength, and they regard the Empire, and Emperor Palpatine in particular, as the most fit and strong force in existence. As such, they are fiercely loyal to the Empire (though the Empire has no great love for them).

Under Imperial rule, the military activities of the Ailon Nova Guard have been reduced since defense is the job of the "real" Imperials (not to mention the Emperor's well-documented prejudices against non-Humans). Consequently, the ceremonial side of their duties has expanded. The annual Ailon Military Ceremonies are a wonder to behold, and virtually every galactic news source provides coverage of the event. There are holofeatures, fireworks, laser displays, flying displays, mock battles, feasts, parades, festivals, displays — anything and everything with a military theme. This is one of the most prestigious events in the military calendar too, and the Empire always sends some of its stormtrooper legions and elite army and naval units as part of the display. There are always plenty of acrobatic displays by TIE fighters and other atmospheric



Ailon Nova Badge

craft, with live holo simulcasts of capital ship fleet maneuvers in system space.

The Emperor, realizing that conquering the Ailon people would be a costly operation, decided instead to harness their uniquely warlike nature to suit his own purposes. Despite his distaste for non-Humans, the Emperor has on occasion used the Nova Guard as "cannon fodder"; however, the orders are presented to the Ailons as a "great battle that only the Nova Guard can perform," in which case the Ailons relish the coming massacre.

■ **Ailon Nova Guard: Average Trooper**

DEXTERITY 4D

Blaster: blaster pistol 6D, blaster: blaster rifle 6D, brawling parry 8D, dodge 6D+2, melee combat 6D, melee parry 6D

KNOWLEDGE 2D

Intimidation 6D

MECHANICAL 3D

PERCEPTION 3D

STRENGTH 3D+2

Brawling 7D+2, climbing/jumping 6D+2,

TECHNICAL 2D

Character Points: Varies, but typically 0-10

Move: 11

Equipment: Nova Guard armor (+1D to head and torso (each) for physical and energy attacks, -1D on *Dexterity* and skills)

Chapter Eight Pirates

“... and now, not only is the Imperial Navy faced with greater and greater challenges as the treasonous Rebel Alliance becomes more experienced in matters of space combat, but the forces of Emperor Palpatine are continually forced to combat pirates in petty skirmishes throughout settled space. And these groups are no longer the rag-tag cutthroats of a few decades ago; they are seasoned combat veterans with a fierce hatred of the Empire. The Navy has its work cut out for it.”

— Excerpt from Kaelldin Krothburt’s *Study of the Galactic Balance of Power: The New Order’s Greatest Challenges*. DataLine Press, datapad entry 542.21, Dx#4/R2P format (restricted government access only).

It is, of course, no great shock to the general public that piracy, especially in the Outer Rim Territories, is on the rise. With the galaxy existing in a state of war, the opportunities for piracy in space are plentiful and highly profitable. What is a bit of a shock is the degree of skill that some of the more prominent groups of pirates exhibit, and the frequent examples of cooperation that these formerly adversarial groups are demonstrating. If these pirates ever form an alliance, the Empire has a major fight on its hands.

The Khuiumin Survivors

“... Fewer than 275 pirates out of 8,000 escaped alive.”

— Account of the Imperial defeat of the Eyttyrmin Batiiv pirate gang

The Khuiumin system was, for many years, the home of the infamous Eyttyrmin Batiiv pirates, until they were scattered and nearly destroyed by the *Victory*-class Star Destroyers *Bombard* and *Cru-sader*. Only a handful of the original pirates escaped, and they are still at large: the 275 survivors went into hiding, spending virtually every free moment training and honing their skills in order to exact bloody revenge against the Empire.

At their peak, the Eyttyrmin Batiiv pirates had over 70 starfighters, 50 yachts, and 28 corvettes,

as well as a number of captured civilian craft. Currently, only one of the pirate corvettes, the *Backstab*, and a handful of starfighters are operational. The mighty pirate armada is no more.

The Khuiumin Survivors now have fewer members than the notorious Void Demons of Isen IV, but have proportionally twice as many pilots, all of whom are *highly* experienced in combat and high-speed attack runs. The Imperial operation pruned a lot of deadwood from the Eyttyrmin Batiiv pirates, and the survivors, under the leader-

Jacob Nive

Type: Pirate Leader

DEXTERITY 3D+1

Blaster 8D+1, brawling parry 7D, dodge 6D+2

KNOWLEDGE 4D

Intimidation 4D+2, planetary systems 5D+1, streetwise 6D, survival 6D, tactics: fleets 7D, value 7D+1

MECHANICAL 3D+2

Astrogation 6D, capital ship gunnery 7D+2, capital ship piloting 7D+2, capital ship shields 4D, sensors 7D

PERCEPTION 3D

Bargain 3D, command 7D, con 8D+2,

STRENGTH 3D

Brawling 6D+1

TECHNICAL 2D+2

Force Points: 1

Dark Side Points: 1

Character Points: 4

Move: 10

Equipment: Heavy blaster pistol (5D damage), hold-out blaster (3D+2 damage), 2 medpacs, vibroblade (STR+ 3D damage), Khuiumin Survivor’s uniform, comlink, datapad

Capsule: Nive is relatively young. He rose to the challenge of the Battle of Khuiumin, and was one of the lucky survivors of the battle that decimated his ship and fellow pirates. A shrewd tactician, his quick action at the battle saved the lives of the remaining pirates, who are now fiercely loyal to him. Outwardly, this young man is composed and disciplined, but he harbors a fierce hatred of the Imperials and occasionally this affects his judgement (“The Imperials are running a supply convoy in Quence Sector. Let’s make them *bleed*.”). He is dedicated to his crew, and will go to great lengths to ensure their safety. He is tall, muscular and handsome. His blond hair is medium length, and he is usually friendly and charming, even to his victims. He prefers to avoid bloodshed when attacking “civilian” shipping, preferring to rob, not kill.

The Backstab

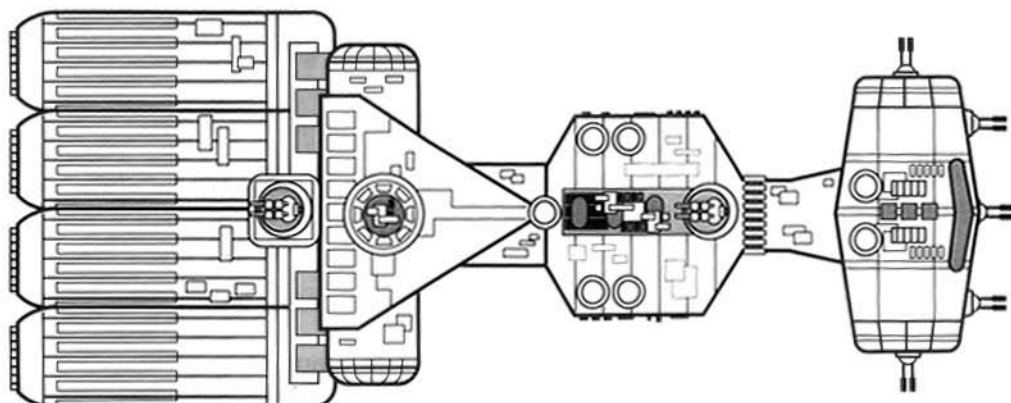

Craft: Corellian Engineering Corporation Corvette
Type: Modified mid-sized multi-purpose vessel
Scale: Capital Ship
Length: 150 meters
Skill: Capital ship piloting: Corellian Corvette
Crew: 145, gunners: 19, skeleton: 25/+10
Crew Skill: Astrogation 7D, capital ship gunnery 7D+2, capital ship piloting 6D, capital ship shields 5D, sensors 5D
Passengers: 40; 20 (troops)
Cargo Capacity: 2,500 metric tons
Consumables: 1 year
Cost: Not available for sale
Hyperdrive Multiplier: x1
Hyperdrive Backup: x2
Nav Computer: Yes
Maneuverability: 2D+2
Space: 6
Atmosphere: 330; 950 KMH
Hull: 4D+2
Shields: 2D+2

Sensors:

Passive: 40/1D
Scan: 80/2D
Search: 100/3D
Focus: 5/4D

Weapons:

8 Double Turbolaser Batteries
Fire Arc: 3 Front, 1 back, 2 left, 2 right
Crew: 2
Scale: Starfighter
Skill: Starship gunnery
Fire Control: 3D
Space Range: 3-15/35/75
Atmosphere Range: 600-3KM/7KM/15KM
Damage: 4D+2
Ion Cannon
Fire Arc: Turret
Crew: 3
Skill: Capital ship gunnery
Fire Control: 2D+2
Space Range: 1-10/25/30
Atmosphere Range: 2-20KM/50KM/100KM
Damage: 3D

ship of the pirate Jacob Nive, are now lean, powerful, and thirsting for Imperial blood. Since Nive assumed command of the pirates, their training has been martial in nature. Nive has insisted that discipline be maintained among his troops and has even required that a uniform to be worn by all personnel on duty.

The formerly ragged and murderous pirates are now more of a mercenary unit. They are still searching for the *Crusader* and the *Bombard* (as well as the ships' captains at Khuiumin) and they long for the day that they have the Imperial vessels in their sights again.

The Khuiumin Survivors. All stats are 2D except: *Blaster* 6D, *dodge* 7D, *capital ship piloting* 4D, *capital ship gunnery* 5D, *starship gunnery* 5D. Move: 10. Heavy blaster pistol (5D+1 damage), knife (STR+1D damage), sword (STR+2D damage), comlink

Thalassian Slavers

Thalassian slavers are not a very disciplined bunch. Thalassians are more like pirates, and when times are particularly hard, they will resort to full-fledged piracy to make ends meet. Sometimes they resort to piracy even when times aren't hard because starship crews have useful skills and command a high price on the open market, not to mention that most Thalassian slavers think piracy is a lot of fun. This means they don't have a good relationship with the Imperials, though. In some sectors, Imperials shoot Thalassian vessels on sight. In other sectors, the reverse is true.

The Thalassian slavers most noted ship is the *Harmzuay*, an old *Kaloth*-style battlecruiser that has been up-gunned to the point that it can eat Nebulon-B frigates for breakfast, and it would probably give a *Victory*-class Star Destroyer a

The Harmzuay

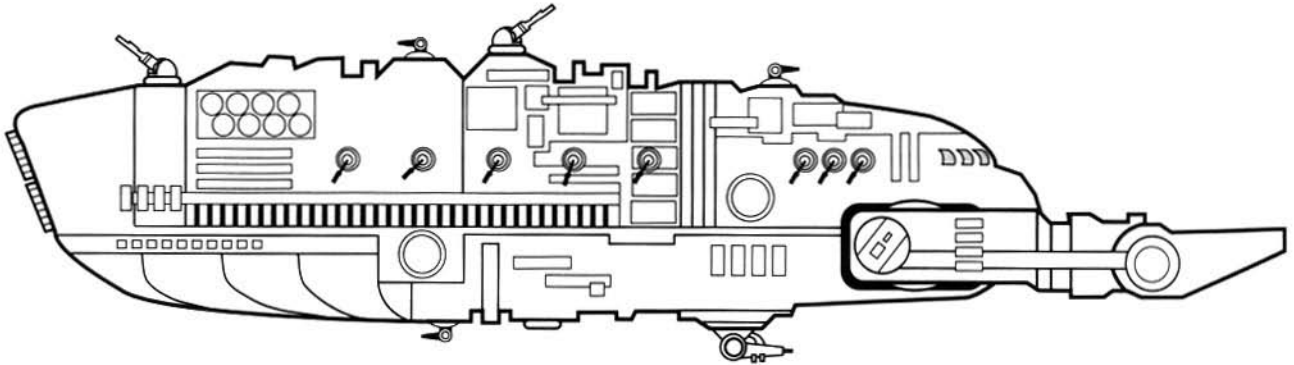

Detail of Tractor Beam Mandibles

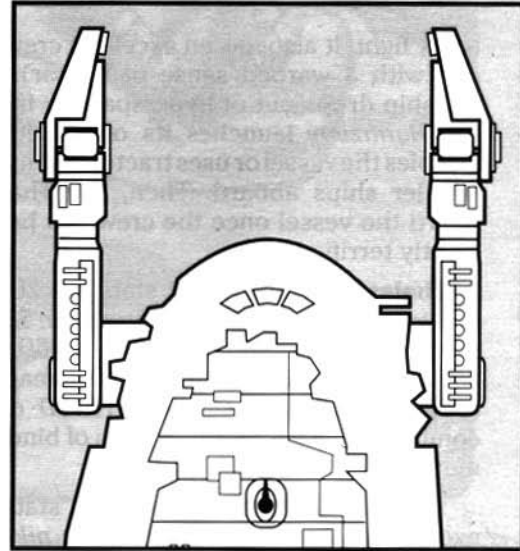

Craft: Kaloth-style battlecruiser
Type: Modified archaic battlecruiser
Scale: Capital Ship
Length: 307 meters
Skill: Capital ship piloting: Kaloth battlecruiser
Crew: 1,240, gunners: 224, skeleton: 540/+15
Crew Skill: Astrogation 6D+2, capital ship gunnery 7D+2, capital ship piloting 6D+2, capital ship shields 6D+2, sensors 6D, starship gunnery 5D
Passengers: 75 (troops)
Cargo Capacity: 6,540 metric tons
Consumables: 6 months
Cost: Not for sale
Hyperdrive Multiplier: x2 1/2
Hyperdrive Backup: x18
Nav Computer: Yes
Maneuverability: 1D+2
Space: 6
Atmosphere: 330; 950 KMH
Hull Code: 4D+2
Shields: 3D

Sensors:

Passive: 40/1D
Scan: 80/2D
Search: 100/3D
Focus: 5/4D

Weapons:

44 Turbolaser Batteries
Fire Arc: 10 front, 15 left, 15 right, 4 back
Crew: 3
Skill: Capital ship gunnery
Fire Control: 3D
Space Range: 3-15/35/75
Atmosphere Range: 600-3KM/7KM/15KM
Damage: 3D+2
24 Laser Cannon (fire separately)
Fire Arc: 8 front, 8 left, 8 right

Crew: 3
Scale: Starfighter
Skill: Starship gunnery
Fire Control: 2D+2
Space Range: 1-3/12/25
Atmosphere Range: 200-600/2.4KM/5KM
Damage: 4D
2 Tractor Beam Projectors
Fire Arc: 2 front
Crew: 10
Skill: Capital ship gunnery
Fire Control: 3D
Space Range: 1-5/15/30
Damage: 4D

Who Says Pirates Don't Have a Sense of Humor?

The freighter *Last Legs* was a dilapidated old *Maso*-class light cargo hauler that had definitely seen better days. *Too bad*, the freighter's captain thought, *today sure ain't one of 'em*.

"Sorry about that, crew," he spoke into the ship's intercom. "The ship's hyperdrive cutout activated in the middle of our jump. Navigator Sellbo to the cockpit please." The captain, an experienced spacer with thousands of hours of flight time logged, turned to stare at the front view screen — and saw an absolutely gigantic letter "H."

"What the blazes is *that*?" Navigator Sellbo had arrived. "Our hyperdrive cutout activated, and dropped us in front of a giant 'H'! What's going on?"

"There's not just an 'H', you know," the captain replied. Sellbo was a good navigator, but he needed some serious salting. "There's an 'A' next to it. And an 'R'. And if you really crane your neck, just off into the

distance, you can see an 'M—Z—U—A—Y.' They're pulling us inside with a tractor beam." A sudden thought struck the captain. He began to laugh. Loudly.

Navigator Sellbo looked sharply at the captain. He had never seen the grizzled old smuggler do anything but scowl. "Uh ... captain? You okay?"

"*Harmzuay!*" the captain howled, slapping his knee. "Don't you get it? HA!"

The *Last Legs* settled into the pirate vessel's docking bay, and the *clank* of magnetic clamps securing the ship echoed eerily in the cockpit. The captain was still laughing.

Navigator Sellbo stared at the captain for a moment, and suddenly understood what was so funny. "Oh, I get it. *Harmzuay*. Harm's way. We're in 'harm's way.'" The navigator grinned, too. "At least these pirates have a sense of humor."

nasty fight. It also has an excellent crew (albeit, one with a warped sense of humor). Once a starship drops out of hyperspace in front of it, the *Harmzuay* launches its own fighters and cripples the vessel or uses tractor beams to bring smaller ships aboard. Then, the Thalassians board the vessel once the crew has been sufficiently terrified.

Thalassian Slavers: All stats are 2D except: *Blaster* 6D+2, *dodge* 7D+2, *intimidation* 5D, *capital ship gunnery* 7D, *capital ship piloting* 6D, *Strength* 3D+2. Move: 10. Blaster pistol (4D damage), knife (STR+1D damage), sword (STR+2D damage), comlink, slave collar, three pairs of binders, two medpacs.

Thalassian Fighter Pirates. All stats are 2D except: *Mechanical* 3D, *starfighter piloting* 5D, *starship gunnery* 4D+2. Move: 10. Blaster pistol (4D damage), flight suit, comlink.

Thalassian Fighters. Modified Z-95 fighters. *Starfighter*, *starfighter piloting* 5D, *starship gunnery* 4D+2. Maneuverability 1D+2, space 7, atmosphere 400; 1,150KMH, hull 4D, shields 1D+2. Weapons: 2 triple blasters (fire control 1D, range 1-5/10/17, damage 4D), concussion missiles (fire control 1D, range 1/3/7, damage 7D).

Dharus

Dharus is a renowned privateer who used to operate along the Leisure Corridor, a trade and tourism route from Coruscant to Ebiwaan (deep in Imperial space). Operating on a route so heavily patrolled by Imperial ships required astonishing audacity and ingenuity, as well as high combat skills, reliable contacts and a fair amount of luck.

Indeed, it was thought for some time that his career had been terminated by the bounty hunter known as Zardra, as Dharus and crew found her waiting for them when they boarded the *Culroon Minstrel*, a *Jesoni*-class liner, about four years ago.

Zardra collected a 40,000-credit bounty for capturing him, but apparently the Imperials weren't able to keep him long enough to put him on trial, because recently "another" privateer, with suspiciously similar mannerisms and mode of speech and with a very similar *modus operandi*, has recently begun operating in Parmel and Sarin Sectors.

Dharus is a Rebel Privateer, who attacks Imperial shipping for profit and gives a share of the proceeds to the Alliance. While he worked the Leisure Corridor, the Alliance supplied him with the necessary intelligence information for him to choose and attack his targets. He *always* seemed to know of any Imperial traps and thus avoid them. He also had a knack for selecting those hostages or prisoners of greatest value to the Rebel Alliance (along with certain Core World residents who wanted to defect). As a result, he was a source of embarrassment to the Empire.

Zardra, unfortunately, being an independent bounty hunter, *and* being good at looking like a harmless Imperial noblewoman, was missed by the Rebel observers, and was able to capture him. Fortunately (for Dharus), the Imperials didn't reckon on a covert operation by the Rebels to release one of their most potent propaganda tools, and Dharus was back in the privateer business within six months of his capture.

Dharus is a humanoid of an unknown species.

He has orange-brown skin and glowing red eyes. He is muscular, tall and in excellent physical condition. He always wears shimmering, multi-colored tunics and black pants, with short utility boots. He wears his long brown hair in what he calls a "ceremonial braid" and his weapons never leave his person.

Dharus has no love for the Empire since his captivity, and has sold his services to the Rebel Alliance in order to take shots at Imperial craft and suitably taunt his victims ("Heave to, you Imperial garbage scow! Prepare to be boarded!"). Boisterous, jovial and loud, Dharus is a fun-loving thrill-seeker.

■ **Dharus**

Type: Pirate Leader

DEXTERITY 3D+1

Blaster: blaster pistol 8D+1, brawling parry 7D+1, dodge 7D, melee combat 6D, melee parry 6D

KNOWLEDGE 4D

Alien species 6D, intimidation 6D+2, planetary systems 5D, streetwise 3D, survival 5D, value 7D+1

MECHANICAL 3D+2

Astrogation 6D+2, capital ship gunnery 6D+2, capital ship piloting 7D+2, capital ship shields 4D+2, sensors 7D

PERCEPTION 3D

Bargain 3D, command 8D, con 6D+2, gambling 6D

STRENGTH 3D

Brawling 6D+1

TECHNICAL 2D+2

Force Points: 2

Character Points: 18

Move: 10

Equipment: Calban Model X heavy blaster pistol (5D+1 damage), hold-out blaster (3D+2 damage), 2 medpacs, vibroblade (STR+1D damage), comlink, datapad

**The Red Lancer and
The Blue Queen**

The vessels *Red Lancer* and *Blue Queen* are affiliated with Dharus' group of pirates. The vessels are heavily modified *Corsair*-class three-man cruisers (bigger than B-wings but smaller than Skipray blastboats). Both have had their available cargo space drastically reduced by the addition of twin capital scale turbolasers and power plants. As a result, the ships are slow and difficult to pilot, while crew quarters are very cramped and uncomfortable. The nav computers are also very prone to failure, apparently because of improper shielding against the power resonance waves from the upgraded weapons systems. These vessels require almost constant maintenance; Dharus is trying to design custom hyper-sleds so the corsairs can reliably travel in hyperspace.

The *Red Lancer* and *Blue Queen* often operate as a team and have recently been spotted in Quence Sector, near Elshandruu Pica. Dharus uses a modified Corellian Gunship, the *Dark Revenge*, as a command vessel.

The ships use the following method of opera-



tion: The *Red Lancer* and *Blue Queen* jump target vessels at their hyperspace exit points and order them to jettison their cargos. If they refuse, they are attacked and disabled with the ion cannon, and then are boarded by crewmen from the *Dark Revenge*.

■ **Dharus' Corsairs**

Craft: Modified SoroSuub *Corsair*-class Cruisers

Type: Heavy assault starfighter

Scale: Starfighter

Length: 18 meters

Skill: Starfighter piloting: Corsair

Crew: 2, gunners: 1

Crew Skill: Astrogation 6D, sensors 5D, starfighter piloting 6D, capital ship gunnery 6D+2, starship shields 5D

Passengers: 0

Cargo Capacity: 15 kilograms

Consumables: 2 days

Cost: 275,000 credits

Hyperdrive Multiplier: x3

Nav Computer: Limited to 3 jumps

The Red Lancer and the Blue Queen

STARBOARD VIEW

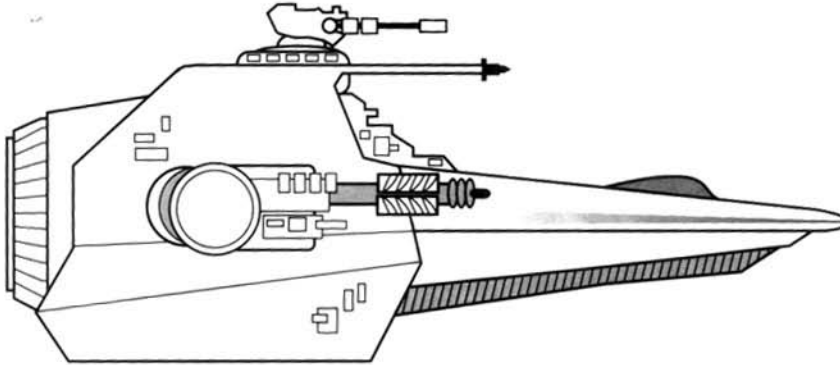

REAR VIEW

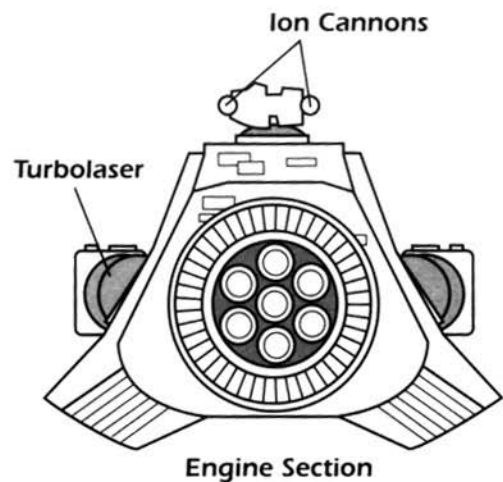

Maneuverability: 1D

Space: 8

Hull Code: 4D+2

Shields: 1D

Sensors:

Passive: 20/0D

Scan: 40/1D

Search: 60/2D

Focus: 3/3D

Weapons:

Two Turbolaser Batteries (fire-linked)

Fire Arc: Front

Scale: Capital

Skill: Capital ship gunnery

Fire Control: 1D+2

Space Range: 3-15/35/50

Damage: 5D

Two Ion Cannons

Fire Arc: Turret

Crew: Fired by co-pilot

Scale: Capital

Skill: Capital ship gunnery

Fire Control: 2D+2

Space Range: 1-10/25/30

Damage: 3D

■ Dark Revenge

Craft: Corellian Engineering Corporation Gunship

Type: Modified mid-sized anti-starfighter warship

Scale: Capital Ship

Length: 120 meters

Skill: Capital ship piloting: Corellian Gunship

Crew: 45, gunners: 46, skeleton: 8/+10

Crew Skill: Astrogation 4D, capital ship gunnery 5D+2, capital ship piloting 4D+2, capital ship shields 4D+2, sensors 4D

Cargo Capacity: 300 metric tons

Consumables: 5 months

Cost: Not available for sale

Hyperdrive Multiplier: x1.5

Hyperdrive Backup: x8

Nav Computer: Yes

Maneuverability: 2D+2

Space: 7

Atmosphere: 350; 1,000 KM/H

Hull: 4D+2

Shields: 3D

Sensors:

Passive: 40/1D

Scan: 80/1D+2

Search: 100/2D+2

Focus: 4/3D+1

Dark Revenge

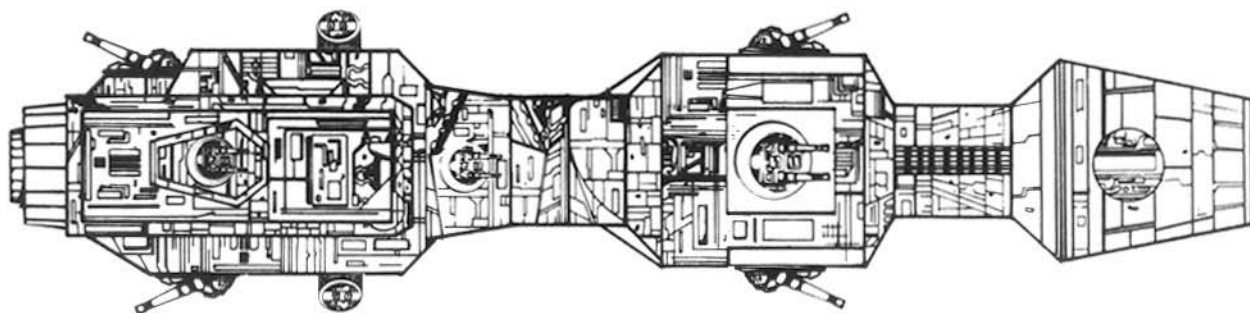

Weapons:

8 Double Turbolaser Batteries

Fire Arc: 2 front, 3 left, 3 right

Crew: 2

Skill: Capital ship gunnery

Fire Control: 3D

Space Range: 3-15/35/75

Atmosphere Range: 600-3KM/7KM/15KM

Damage: 4D+2

6 Quad Laser Cannon

Fire Arc: 3 left, 3 right

Crew: 3

Scale: Starfighter

Skill: Starship gunnery

Fire Control: 3D

Space Range: 1-5/10/17

Atmosphere Range: 100-500/1KM/1.7KM

Damage: 5D

4 Concussion Missile Tubes

Fire Arc: 2 front, 2 rear

Crew: 3

Skill: Capital ship gunnery

Fire Control: 3D

Space Range: 2-12/30/60

Atmosphere Range: 200-1.2KM/3KM/6KM

Damage: 9D

Capsule: The *Dark Revenge* is Dharus' new command vessel, and this Corellian Gunship means business. The *Revenge* has not only gone directly against hordes of Imperial TIE fighters, but it has defeated an Imperial Star Galleon. Dharus' command skills have helped forge a battle crew that very effectively functions as a unit, while building a new pirate legend in the Outer Rim Territories.

Chapter Nine

Swoop Gangs

Swoops are among the most dangerous vehicles available to civilians. A good swoop pilot needs to have daring, amazing reflexes and almost no fear of death. In recent years, swoop gangs have risen to prominence in outlying areas; increasingly, they are compared to the most fearsome pirate gangs. While not all swoop gangs are alike, *most* have a callous disregard for life, property and the rule of law: they take what they want when they want, and have caused countless civilian casualties.

The Skulls

The swoop gang known as The Skulls were founded by a vicious seventeen-year old street hood on Stend VI who was bored with picking pockets and shaking down frightened store own-

ers for protection money. Jeng Seth, a truly sociopathic individual, developed a love for speed and danger while growing up in the back alleys of what was essentially a lawless world. When he "procured" a swoop from a local dealership, he instantly fell in love with the vehicle and has been honing his skills with it ever since.

Gathering a group of his street friends, he formed the Skulls, and now, nearly six years later, the Skulls have relocated to the Hook Nebula. Their conflicts have brought them into battle against local militias and law enforcement agencies, Imperials and Rebels; they have been hunted by bounty hunters, and have been generally loathed and feared by everyone they met. Jeng Seth has been the subject of several unauthorized biographies and a holoseries. He has come



to relish the bloodthirsty reputation the media has given him over the years. Needless to say, Jeng Seth is no longer bored.

The Skulls are certainly one of the most feared swoop gangs currently in existence. Their notoriety is well-deserved: members of the gang delight in acts of senseless violence, and they never seem concerned that their targets are unable to defend themselves. The message is simple enough: if you don't get out of the way, expect to be run down. The Skulls use their swoops more as weapons than as a means of transport.

The Skulls' attempt to acquire wealth and possessions, terrorize innocents, and do whatever happens to seem amusing at the time. The Skulls somehow manage to find transport from planet to planet so it has been very difficult for the Empire to track their progress and defeat the group (of course, the defeat of the Skulls isn't a top priority for the Empire, either).

Common methods of attack used by the group include flying an armored swoop into the middle of a dense crowd, and then relieving anyone injured or killed of their cash and valuables. Similarly, pairs of swoops may fly along, carrying heavy objects between them (concrete pillars and steel bars are common choices) and then drop these items on their intended targets. Flying past while spraying the area with blaster bolts is another popular technique, and so is simply setting a swoop to hover at a convenient point and using innocent people as a sort of live arcade target shoot. The Skulls attack without warning or provocation, and the speed of their actions leave the helpless victims with little or no time to react.

Since the introduction of the repulsorlift sled by the Empire, the Skulls have been required to be more clever in their actions. The Skulls have been observing the deployment of the newer, faster sleds, and ambushing the Imperial soldiers if they are few in number. This results in still further embarrassing defeats for the Empire.

Conversely, if the Empire does deploy sufficient force to deal with them, the Skulls are usually happy to fight a strategic retreat, heading into a sufficiently populated area. In these areas, they are able to use "ants" (civilians) as cover, and the Imperial troops are then hampered by their reluctance to cause further civilian casualties or property damage. The Skulls, of course, have no such qualms. Once sufficient havoc has been wrought, the Skulls use their swoops' superior maneuverability to melt away through the back streets, leaving the Imperials chasing phantoms.

In the Skulls' sphere of influence in the Hook Nebula, the morale of the Imperial troops who have faced this continued insolence is at an all-

Jeng Seth

Type: Swoop Gang Leader

DEXTERITY 3D

Blaster 5D, blaster: blaster pistol 6D+2, brawling parry 6D+1, dodge 6D, melee combat 6D, melee parry 6D, pick pockets 6D+1

KNOWLEDGE 2D+1

Intimidation 6D+1, willpower 6D

MECHANICAL 4D

Swoop operation 8D

PERCEPTION 3D

Command 7D, con 7D, gambling 5D+2

STRENGTH 3D+2

Brawling 5D+2

TECHNICAL 3D

Repulsorlift repair 7D, security 6D

Force Points: 3

Dark Side Points: 2

Character Points: 14

Move: 10

Equipment: Heavy blaster pistol (5D+1 damage), vibroblade (STR+3D), blast vest (+1 energy, +1D physical), racing swoop, comlink

Capsule: Jeng Seth still looks much like he did when he formed the Skulls swoop gang. He is of medium height, but strongly muscled and fit. He usually wears black trousers and boots, a blue tunic and a worn flight jacket with the Skulls insignia on the left shoulder. He is cocky and arrogant, and lives to terrify anyone he meets. If he is not in control of a situation, he becomes very angry and violent; he has a frightening bloodthirsty streak ("Let's ace those stupid civilians!").

time low. These continuing defeats are through no fault of the Imperial repulsor sled crews. If the Skulls were in the military, they would be a top-notch mechanized unit. This factor, combined with their souped-up swoops, means that even the better repulsorlift sled pilots stand little chance of gaining any major successes against them. A completely different strategy is required to deal with the Skulls, and the Empire has been working hard to find one. So has the Rebel Alliance: this gang is a menace, and removing them would be a public service.

The Skulls. All stats are 2D except: *Dexterity* 3D, *blaster* 6D, *swoop operation* 7D+2, *streetwise* 6D+2. **Move:** 10. Blaster pistol (4D damage), blast vest (+1 energy, +1D physical).

Skulls' Swoops. Modified Mobquet Nebulon-Q Swoop Racer, speeder, maneuverability 4D+1, move 260; 750KMH, body strength 1D, altitude range: ground level — 50 meters. Weapons: one light blaster cannon (fire control 1D, 3-50/100/200, damage 4D+1).

The Knights

The Knights were founded in much the same manner as the Skulls, their "traditional" arch-enemy. Finegan Flint was a twenty-year old swoop

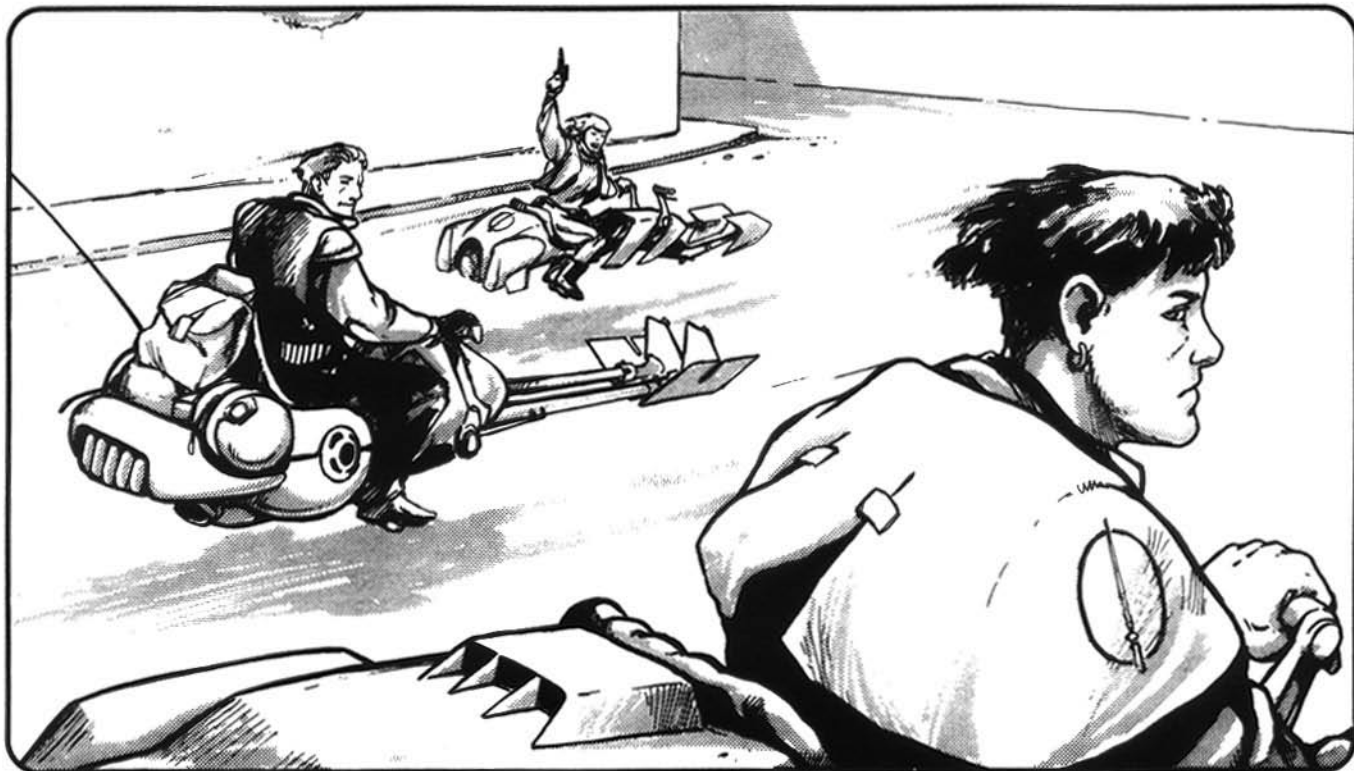

mechanic, an idealist and dreamer, who lived on Stend VI. He was fascinated by books and holos depicting the historical and fictional lives of the Jedi Knights of the Old Republic. As the Skulls made a name for themselves in the local news by terrorizing the people of Stend VI and the local military showed utter contempt for the safety of the citizenry, Finegan Flint began convincing his friends to band together to stop the Skulls.

He started a running feud with the rival swoop gang when he and his friends confronted one of the Skulls and told him to surrender himself to the local police or *else*. Soon the occasional skirmish escalated to a gang war. The Knights dedicated themselves to the ideals of the Jedi, namely, the protection of the innocent and the powerless from the corrupt and strong. Unfortunately for the Knights, their "honorable" traits have made them far easier targets for the repulsorlift sled units of the Imperial military. In addition, the Skulls generally are more skilled and certainly more ruthless than the Knights, and these factors have resulted in a slow decline in the Knights' membership. The best riders in the Knights are so highly skilled that they can afford to act in the idealistic manner that they do, but barring outside interference, the gang will eventually dwindle to a core of about a dozen riders who won't be able to do much of anything despite their dazzling level of skill.

Given that the Knights are on a fast track to oblivion, the local Alliance contact has consid-

ered recruiting them into the Rebellion as a repulsorlift scout company. This would require some delicate negotiations on both sides, and would also require someone to make the first links with the gang so that the Alliance could make a reasonable judgment on how feasible this would be. It's possible that if the Knights were given something worthwhile to fight for, they might actually be able to achieve the high ideals of their founder.

The Knights. All stats are 2D except: *Dexterity* 4D, *blaster* 5D+2, *streetwise* 6D+2, *swoop operation* 6D+2. Move: 10. Blaster pistol (4D damage), blast vest (+1 energy, +1D physical).

Knights' Swoops. Modified Skybird Swoop, speeder, maneuverability 4D, move 225; 650 KMH, body strength 1D, altitude range: ground level—50 meters. Weapons: one blaster cannon (fire control 1D, 3-75/150/250, damage 5D+1)

■ Finegan Flint

Type: Knights Founder

DEXTERITY 3D

Blaster 5D+1, blaster: blaster pistol 6D+1, brawling parry 6D, dodge 5D+2, melee combat 6D, melee parry 6D

KNOWLEDGE 2D+1

Cultures: Jedi Knights 8D, willpower 6D+2

MECHANICAL 4D

Swoop operation 7D+2

PERCEPTION 3D

Command 7D, persuasion 7D

STRENGTH 3D+2

Brawling 5D

TECHNICAL 3D

Repulsorlift repair 7D, security 6D

Force Points: 2

Character Points: 11

Move: 10

Equipment: Blaster pistol (5D+1 damage), blast vest (+1 energy, +1D physical)

Capsule: Finegan Flint is tall, thin and bony. He looks more like an academic or philosopher than a swoop gang leader. He is always dressed in his flight suit, which has the insignia of the Knights emblazoned across its back. He has short black hair and a long, drooping moustache and beard. He is always calm and polite, though he fights like a man possessed when in combat. He has taken on the noble mission of stopping the Skulls, and is fully focused on that task ("We must stop these ... *villains*. We must stop them before someone is injured.").

The Bloodsniffers

Named after a dangerous predatory creature, the Bloodsniffers swoop gang has haunted the isolated worlds of Quence Sector for nearly a decade. No one knows the history or origin of the gang — they simply appeared on the border of a small farming community on Xiunsrus one morning. One of the gang members demanded 10,000 credits by afternoon. When the town refused, the Bloodsniffers destroyed the village.

Since that time, the gang has travelled from world to world, finding isolated communities, cutting off any communications and then extracting whatever booty could be had. The Bloodsniffers seem to investigate each town carefully, making sure that their targets have insufficient local law to defend themselves and that the towns are far enough away that additional aid couldn't arrive in time to make a difference.

The Bloodsniffers are noted for their bright red swoops and jackets. It is believed that there are currently over 100 riders in the gang, with some support crew, groupies and assorted minions and hangers-on who seem to relish this outlaw and despicable lifestyle.

Bloodsniffer. All stats are 2D except: *Dexterity* 3D+1, *blaster* 4D+2, *vehicle blasters* 5D, *swoop operation* 5D+2, *Strength* 3D. **Move:** 10. Blaster pistol (4D damage), jacket (+2 energy, +1D physical), helmet (+2 energy, +1D+2 physical).

Bloodsniffer Swoops. Modified Kuat Vehicle Swoop, speeder, maneuverability 4D, move 260; 750 KMH, body strength 1D+1, altitude range: ground level — 50 meters. **Weapons:** one blaster cannon (fire control 1D+2, 3-50/100/200, damage 4D).

Chapter Ten

The Force

Lightsaber Practice

"While it is true that a Jedi uses his power only for defense, never for attack, it is equally true that a Jedi must nevertheless prepare with great vigilance, for only the Force knows when you may face your greatest battle."

— Excerpt from Jedi Master Vo'ren Faalo's *Book of Practical Lightsaber Technique*.
Novacron Press, 162. S*D/3/r^6.56.
All formats now banned.

The Jedi are renowned for their skill with that most elegant of personal weapons: the Jedi lightsaber.

While there is no denying that the lightsaber is lethal in skilled hands, the amount of training and practice required to achieve any degree of skill is staggering. True competence comes from not only

training the reflexes, but from training the mind as well. All too often young Jedi have superior physical skills, yet their ability to concentrate and relax their minds is lacking.

Like other Masters before him, Jedi Master Vo'ren Faalo developed his own formal lightsaber training for his young apprentices. Some Masters studied his practice techniques (which he called "cadences") and adopted them as part of their own training for their Jedi. The following descriptions of Faalo's Jedi cadences are extracted from volume seven of Faalo's writings on lightsaber technique.

Materials

Faalo's cadences require several specific materials. Steel ball bearings of no more than 1 millimeter in diameter are recommended for these exercises; half a kilo is just under 100,000 bear-



ings, and costs no more than 3-5 credits. The candles can be produced by any autochef.

On some worlds, where mass-produced steel ball bearings, autochefs and wax tapers are not so commonly available, this exercise is done using unlit candles. The object is to light each candle by contacting the lightsaber blade with the wick. This exercise would seem easier than the traditional technique were it not for the fact that candles, particularly those created on low-tech worlds, do not show the consistency of length that many Jedi rely on to complete this exercise. This cancels out the bonus attached to hitting the larger wick target. Some Masters prefer this less technologically-based exercise as more elegant and aesthetically pleasing.

First Cadence

Duration: One hour

Preparation: Make a batch of 19 wax cylinders (10 centimeters high and half a centimeter in diameter) using an autochef. Also obtain 190 metal (ideally steel) ball bearings.

Cadence: Start by placing one cylinder upright directly ahead of you at a distance of one to one and a half meters (so that you can just reach it with the tip of your lightsaber), and place one of the ball bearings on top of it. Then, from the rest position, draw your saber, ignite it and strike the ball bearing. Your object is to completely evaporate the ball bearing without harming the wax cylinder it rests on. This requires that you strike to within one millimeter accuracy.

During the early stages of this cadence, a slight scorching of the cylinder is acceptable. If, however, it is physically distorted to a perceptible degree (by *touch*; remember the Guide of Perception) then you have made an error and you should restart the cadence from the beginning.

Having successfully completed one ball bearing, place two cylinders directly ahead of you, *by hand*, with a 10 degree angle between them. The first few times you perform this maneuver you should check the accuracy of your placement with a protractor or anglebeam. No more than a two degree error is permissible.

When you become comfortable with this exercise, you should be able to place the cylinders with no more than a tenth of a degree error without needing to check. Talk to your tutor if you find this difficult.

Having successfully completed two cylinders, you should attempt three, again spaced at 10 degree intervals ahead of you. Then four cylinders, then five, and so on until you cover the full 180 degree spread with nineteen cylinders.

Once you have completed all nineteen cylinders, you may want to obtain additional ball bearings for repetition purposes. There are a number of

orders that you should remove the ball bearings in: From right to left; left to right; alternate left and right working out from the center; alternate left and right working in to the center; and, random. Your teacher may suggest others. Only when you can perform all possible permutations two-handed, left-handed, right-handed and blindfolded with equal facility are you ready to advance to the Second Cadence.

Game Notes: This cadence, while seemingly a primarily physical task, requires the utmost in mental discipline and calm to successfully complete. The difficulty to place the cylinders for the first cadence is Moderate with *Control*, Easy with *Sense*, and Very Difficult if using *Dexterity* or *Perception*. Hence Vo'ren Faalo's warning: "If you find this difficult consult your tutor." If the Jedi-in-training is trying to use one of his attributes to perform this exercise, he has failed to understand exactly what is required of him.

Performing the initial exercise (one cylinder and ball bearing) requires a Heroic *lightsaber* skill roll, a Difficult *lightsaber* roll if used with a Moderate *control* roll, or a Moderate *lightsaber* roll if used with a Moderate *sense* roll. Each time the Jedi successfully completes one phase of the cadence, reduce the difficulty by one level (minimum of Easy difficulty).

Each subsequent step of the cadence has the same level of difficulty as the initial task, with modifiers based on the number of cylinders:

- +5 for two to ten cylinders.
- +10 for eleven to nineteen cylinders.

Each time a phase of the cadence is completed, reduce the difficulty by one level (with a minimum of Easy).

The gamemaster may also add modifiers based on variations, for example, adding +5 to the difficulty for left-handed; +10 for drawing the saber and left-handed; +20 for blindfolded, drawing the saber and left-handed.

The student is expected to learn to spend time preparing for this task, and he must master keeping his *control* roll up while demonstrating his or her proficiency with the lightsaber.

In order to advance to the second cadence, the entire set of exercises must be completed one after the other within the allotted one hour. This cadence may be simulated by only two or three die rolls instead of rolling for every ball bearing.

If the student has any Dark Side Points, every Dark Side Point raises the difficulty of this exercise by five points. This is because the lesson requires a great deal of inner calm to be completed, and the Dark Side destroys this calm. An astute Jedi might use this cadence as an indication of how badly he or she has been tainted by the Dark Side.



Once the cadence has been completed, the Jedi will always be able to complete it at will, unless his difficulty number rises later for some reason (such as gaining a Dark Side Point). Therefore, even though the dice might not cooperate, once a Jedi has succeeded once he will always be able to manage this exercise unless he has accumulated Dark Side Points.

Second Cadence

Duration: Two hours

Preparation: The second cadence requires 72 cylinders and 2,701 ball bearings.

Cadence: The cylinders must be placed at five degree intervals (rather than 10 degree intervals); by the end of the cadence a full 360 degree circle is covered. There should be *two* ball bearings at the zero degree position, so that you can start and end at zero degrees.

Where the first cadence allows over 18 seconds to place each cylinder and complete the saber strike, the second cadence permits just under three seconds to complete each one.

This cadence requires the Jedi to be able to strike accurately at all points around him. In the easier versions, you are permitted to turn to face the point at which you are striking. Once you have mastered this, you are expected to be able to strike at any point around you without having to turn at all; simply reach with the saber and use the Force to guide the stroke.

Game Notes: The second cadence requires a

Moderate *control* roll to place the cylinders (or an Easy *sense* roll). Completing the each step of the cadence requires a Heroic *lightsaber* roll with a Moderate *control* or a Moderate *lightsaber* roll with a Difficult *control* roll. Make six rolls to summarize the entire cadence. This assumes that the Jedi has completed the first cadence.

Third Cadence

Duration: Three hours

Preparation: The third cadence requires a total of 180 cylinders and 16,290 ball bearings.

Cadence: The cylinders are placed at 2 degree intervals, and the strike patterns used generally involve destroying every fifth ball bearing, then every fourth of the remainder, then every third, and so on until none are left. The exercise allows only one third of a second to complete all placements and all strikes.

Game Notes: The third cadence requires a Difficult *Sense* roll to place the cylinders. Completing the cadence requires a Heroic *lightsaber* total, a Heroic (with a +15 modifier to the difficulty) *control* and a Difficult *sense* total, rolling once for each hour of the cadence.

Fourth Cadence

Duration: Four hours

Preparation: This cadence requires 360 cylinders. By now the student should know whether his strike is accurate enough and therefore no ball bearings should be needed. Instead, the

The Divoran Holochess Players

"Ah, yes, Hart Daele. Yes, I remember Daele very well. Charming man. Stuffy, of course. You know how theoretical mathematicians can be; imagine a *Jedi* theoretical mathematician. Stuffy isn't the word.

"At that time I was living on Damualer Triac with my second wife, Hannah, and he was stationed in Samarine Province, about seven kiloparsecs away. We were engaged in a marathon Divoran holochess competition. You know the game, right? Each player controls fifteen holographic armies on a multi-level playing board, and the object is to capture all fifteen of the opponent's Emperor pieces. He came out two games ahead by the end of it, the little walking abacus.

"Anyway, it took us a little while to get to know each other's playing style, about five years or so, but after that, whenever he thought I wasn't concentrating, he'd use a computer to make his moves. I could always tell; the quality of game play dropped noticeably. That was the point, of course; a gentle prod to get *me* to play better. Ah well. There weren't many people who were able to match Daele at Divoran holochess ... He certainly made me work hard enough.

"Where was I? Ah. At this time there used to be a beautiful forest about two kilometers to the south of my home, and I regularly used to walk there. And always, just when I went past this storm-blasted Millennium Oak, I used to hear his ethereal voice coming from nowhere saying, 'Lancer to Queen's Second Plane 4' — he used to use the *old* chess notation, y'know — and I always used to stop still, raise one finger, and say, 'I shall make a note,' before continuing with my walk. We had that routine going for well-nigh forty

years ...

"No, it never has been true that the Jedi can only farsee across stellar distances. Daele and I played thirty chess games like this, and that takes projective telepathy ... All our limits come from within ourselves. Saves a fortune in communications bills ...

"I used to send my reply to him just before he was sitting down to dinner. He had the chessboard in his private quarters — a beautiful crystal set, his — and that meant he could make the move on his board as soon as I had told him.

"The picture? Oh, just my little hobby. I have always liked chess, and I enjoy holographic painting ... I've done a number of boards in different styles, with different backdrops. That one was challenging because the pieces are very reflective and in those odd, twisty shapes, which meant that the reflections of the planet behind them appeared in some strange places. Oh no, it's far too cold for the sitting room, but it fits in quite well here. My wife says she doesn't like it because she ends up staring at it for hours without being able to make any sense of it. It does tend to make people ... uncomfortable. Ah, well. It's a check position actually, but the illusion makes it hard to decipher. I'll give it away one day, when I find someone it suits.

"I think that's enough about Divoran holochess for now. Have some more spice liqueur, and I'll tell you about the rest of the clan ..."

— Excerpt from "An Interview With Haaran Balmor, Jedi Master," from Madelein Aurin's book, *Heroes Of The Republic*, Sarlain Star Press, 96.72 (All Formats Now Banned)

cylinders themselves should be 10.1 centimeters long with a raised center.

Cadence: Place the cylinders at 1 degree intervals. The saber strikes must be made in patterns corresponding to a series of complex mathematical equations. This means that on top of the fact that the Jedi can afford barely over one fifth of a second to strike, he also has to perform the complex calculations needed in his head without error and without slowing down.

Game Notes: The fourth cadence requires a Heroic *lightsaber* roll, a Heroic (with +25 modifier) *control* roll, and a Heroic *sense* roll while performing complex mental calculations (a Difficult *Knowledge* roll, or an additional Difficult

control roll). Roll once for every ten minutes of the cadence. Many Jedi are still working on this Cadence at the time they complete their training.

Fifth Cadence

Duration: Three hours

Preparation: By this stage there is no longer any need to use large numbers of ball bearings or wax cylinders.

Cadence: Completing this cadence is the mark of a Jedi Master. The Jedi can know exactly where the cylinders would have been; therefore they are no longer needed.

For the first two hours, the Jedi must concentrate to make strikes at the appropriate loca-



tions, with a Heroic (with +25 modifier) *lightsaber* roll, a Heroic (with +35 modifier) *control* and a Heroic (with +25 modifier) *sense* roll, while performing complex mental calculations (a Difficult *Knowledge* roll, or an additional Difficult *control* roll). Roll once for every ten minutes.

For the final third of the cadence, the Jedi must use the *telekinesis* Force power to levitate his or her lightsaber and perform the saber strikes. The Jedi must stand in the "middle" of the imaginary candle circle, so the lightsaber must be maneuvered around him. This requires a Heroic *control* roll, and the *telekinesis* difficulty is Heroic +60 (to be rolled once every ten minutes).

The Remote

The remote is a very old and surprisingly subtle form of Force training. The object is for the student to use his *lightsaber combat* skill to reflect an attack

back at the globe sufficiently accurately to deactivate it (See page 151 of *Star Wars: The Roleplaying Game, Second Edition*). Most remotes contain an on-board micro-processor that allows it to perform under its own power, and can have anything from 2D to 6D in *stunner* and/or *dodge*. The bolts it fires can likewise be set to do from 1D to 3D stun damage. The globe may be set to have 1D to 7D *Strength* for damage resistance purposes. More lethal versions of remotes have been known to be employed as sentry or assassination units.

Tricks such as using *absorb/dissipate energy* to fend off the stun bolts should be used by the pupil to help him complete the exercises. While acting under tuition, the tutor may forbid the pupil from using some of these tricks in order to stretch different areas of his skill, and may also require the student to be blindfolded, to use his saber left- or two-handed, or to only draw it on being attacked in order to make the exercise more difficult.

One major point that this exercise covers is "what if the Jedi-to-be uses his *sense* skill to guide a lightsaber attack against the globe itself?" This is using the Force for attack, which is an offense that would normally gain the pupil a Dark Side Point. Fortunately, because this is a training exercise, this penalty does not apply, and the flaw may be corrected without further harm being done, though the pupil may be rebuked by the Master for violating the procedures of a defensive exercise.

The Oxygen Bottle

The object of this training exercise is, starting with an empty bottle and a vacuseal stopper, to finish with a bottle of pure oxygen, extracted from air, using only Force skills. It is yet another test of a Jedi's mental discipline and concentration, and teaches the student how to extend his awareness and control beyond the readily perceptible. The base time to perform this exercise is one day. This task requires knowledge of the *telekinesis* power, and all difficulties apply to this power.

Step One: Emptying the Bottle

First, the bottle must be completely emptied. Jedi tend to take a very literal view of this type of instruction; completely emptying the bottle means evacuating it to as close to a 100% vacuum as possible. A 10% vacuum requires a Difficult roll (this reduces the pressure inside the bottle from 1 atmosphere to 0.9 atmospheres). A 90% vacuum requires a Very Difficult roll. A 99% vacuum requires a Heroic roll, a 99.9% vacuum requires a Heroic (with +15 modifier) and so on. This power must be kept up or the bottle will immediately flood with air again.

At any time, a roll of 60 will tell the Jedi exactly how many molecules remain within the bottle at any given time. One corollary of this is that on a Very Difficult *sense* roll for any Jedi with the *teleki-*



nesis power, the Jedi can tell how much something weighs to the nearest 0.001 milligram.

Step Two: Filling with Oxygen

This is the *really* difficult part. The Jedi must now permit oxygen molecules (and no others) to re-enter the bottle. His earlier *telekinesis* roll must be kept up, he needs a Difficult *sense* roll in order to identify the molecules he is supposed to be admitting, and he needs a Heroic *telekinesis* roll in order to make his barrier selectively permeable.

This process normally takes 12 hours. The Jedi must roll once for each hour. The Jedi may speed up the process, by adding +10 to the difficulty of each roll for each hour saved.

Telekinesis Practice

Duration: One hour

Preparation: You will need one small ball, ideally marble-sized, and a hollow hemisphere of at most twenty-five times the radius of the smaller ball.

Task: Place the hemisphere on a flat surface with the ball inside it. Then use the Force to anchor the position of the hemisphere so that it does not rock. Having done this, use the *telekinesis* power to exert a perpendicular force between the marble and the hemisphere. Finally, begin *rolling* the marble up the inside of the dish.

The dish must remain completely steady, despite the normal force acting upon it, and the marble must not slip. If it does slip, or if the bowl

moves, you are applying insufficient force. Roll the marble up the side of the dish and “curl it out” onto the hemisphere’s lip.

Rest.

Then roll the marble back down to the center of the bowl. Do not permit it to roll of its own accord, or to overshoot its mark. Once you believe that the marble is at the bottom of the bowl, release your hold on it. If it moves perceptibly, you are not placing it accurately enough. If the bowl moves, you are applying too much force.

The Muntuur Stones

It is said that the Jedi Master Ferleen Snee was once found standing next to the Muntuur Stones with a distracted expression on his face and the multiple Stones gliding about in the sky above him, and seemingly in imminent danger of crushing a pair of tourist sail barges. The tourists were either too scared to move or completely transfixed by the spectacle, depending on whose story you choose to believe, and the Planetary Enforcers were summoned to try to arrest Snee for threatening behavior.

This was not a job they relished, as Snee at this time was said to be a rather irascible old misanthrope, and when they eventually plucked up the courage to approach him, he shooed them away bad-temperedly with the words, “Go away! I’m only practicing!”

The heaviest of the seven Muntuur Stones weighs over five metric tons. This story has never been verified ...

Calibration Check

Corwin Shelvay stood in an empty engineering laboratory at the Ansarra Rebel base. Shelvay examined the brand new unit, just delivered three days ago. It certainly was expensive-looking: the fully-equipped model came with an atmospheric sample analyzer and draught-proof casing around the sample receptacle. The device was so new that there were still pieces of packaging littered about the work bench where it has been placed.

Shelvay looked quizzically at the figure given on the unit's digital read-out. He paused for a while, falling deep into an old Jedi meditation. After a while, the unit's digital readout began to fluctuate wildly.

A technician, with a surprisingly unhurried demeanor for a Rebel tech, walked past, and Shelvay stopped him.

"Excuse me," said Corwin, the Rebel base's resident Force sensitive. "I hate to be the bringer of bad tidings, but this unit is giving faulty readings."

Looking puzzled, the technician studied the readings. "Sorry, sir, but I don't see any variance with base standard readings."

Corwin smiled calmly and replied, "They are between point one and point three per cent too high."

"What are you talking about? We calibrated it using the manufacturer's own control group!"

"Yes, that's partly what caused the problem. The gram mass only weighs 0.9999973 grams, and the milligram mass only weighs 0.99822 milligrams. The other standards are also out."

The technician was becoming annoyed. He was not a great believer in the Force. "You're kidding," he said.

"I'm afraid not. I think you should check the unit's calibration again."

"Yeah, sure." *That's only a level ten diagnostic routine that'll take two hours, but who cares, right?*

After a moment the harried technician added, "Hey, wait a minute. The scale's circuitry should have picked up on that. It should have *told* us that at least one of the masses was out. I'm sorry, Commander, but I don't think it's likely that this unit is wrong. I mean, we're using it as a standard for the entire base, and we've already had to re-calibrate half the other scales on the base."

Raising an eyebrow, Shelvay responded with a simple, "Really?"

Shrugging, the technician was inwardly pleased to have this unwanted problem solved. "Stranger things have happened, sir."

"You're saying that scales that have functioned perfectly well for years on end suddenly appear to be significantly out of adjustment?" Corwin asked.

"Yeah ... Are you saying its fault-detection circuitry is out too?" *Here we go again*, the technician winced inwardly. *He's going to say yes.*

"Yes, I am," replied the Jedi.

The technician had had just about enough. "Oh, really? Well, this is the most accurate analyzer on the base. Just exactly where did you weigh the standard masses to ten billionths of a gram?"

Trying to look innocent, Corwin shrugged and said "Ah, there are ways ..."

"Such as?" The technician was still suspicious of the Force-user, and was starting to remember the base scuttlebutt about Corwin's abilities.

"You don't have to take my word, of course. Why don't you check for yourself?"

The technician remembered the story that some of his fellow engineers had told in the mess hall that morning. Something about Shelvay purifying all the air in a bottle and knowing within a thousandth of a gram exactly what was in it. *And here I thought I could relax.* "I'll check it at once, Commander," he sighed.

Repeat 35 times, rolling the marble out to a different point on the lip of the hemisphere each time.

As a variant, invert the bowl and place the marble next to it on the floor. Then roll the marble up the outside of the hemisphere until it has reached the middle. Release your hold momentarily, then re-engage before the marble has moved. The accuracy of your placement is of paramount importance; otherwise you will not have time to release and re-exert your hold before the ball has begun to move. Finally, roll the marble back down the hemisphere to a different point on the floor. Repeat 35 times.

A second variant on this exercise involves

precisely anchoring the position of the ball, rather than the bowl, then sliding the bowl out from under it in such a way that the friction between the marble and the bowl is sufficient to cause the marble to rotate in place. Once the marble is free, continue to rotate the bowl in space until the opposite lip engages the marble once more. Continue until the marble is once more at the bottom of the bowl. Release your hold. If the bowl moves noticeably after you have released it, you have either overshot with your rotation, or not gone far enough. If the marble moves, then you allowed its position to drift during the exercise. As before, repeat 35 times, turning the bowl in a different direction each time.



Game Notes: This task requires an Easy *telekinesis* total, with a +15 difficulty modifier due to the complexity and subtlety of the maneuvers.

Telekinesis Practice Two

Duration: One hour

Preparation: You will require a number of balls of equal size. 3D-billiards balls are a good size to use to begin with.

Task: In the simplest exercise, simply stack the balls one atop the other as high as you can go. Then experiment with forming arches, free-floating structures, inverted pyramids, orbital systems and so on. Try building the balls in as many different orders as possible — from the floor upwards, from the apex downwards, from the center outwards, and at random — so that you have to levitate and insert balls through narrow gaps.

Game Notes: This task requires the *telekinesis* Force power, requiring anywhere from a Moderate to Heroic totals; additional modifiers may be applied as necessary.

New Force Powers

Control Powers

Instinctive Astrogation Control

Control Difficulty: Very Difficult. Modified by *astrogation* difficulty.

Time To Use: One minute

Effect: *Instinctive astrogation control* is far more

difficult than the standard *sense*-based *instinctive astrogation* power because instead of trying to “feel” the correct solutions to the hyperspace equations, the Jedi calculates them in his head. This is quite possible, and is often done as a training exercise, but the figures generated are rarely utilized because it is so easy even for a Jedi to make a mistake.

The difficulty is modified by how hard the task is with a nav computer:

Task is:	Modifier (add to difficulty):
Very Easy	0
Easy	+5
Moderate	+10
Difficult	+15
Very Difficult	+20
Heroic	+30

If the *control* total is successful, a Very Easy *astrogation* roll is necessary to enter the correct routes into the nav computer. If the Jedi fails the attempt, he overlooks an obstacle, and sends the ship down an inherently dangerous path and thus instead of requiring a Very Easy *astrogation* total, the difficulty is automatically Very Difficult. If the *control* roll is missed by five or more points, increase the difficulty to Heroic.

This is a largely unknown application of the *control* power that allows Jedi to plot *astrogation* paths, instead of using the more well-known *sense*-based *instinctive astrogation* power. *Instinctive astrogation control* is little more than a curiosity, studied only by a few theoretical Jedi, the most

prominent of which in recent memory was Hart Daele. In fact, Daele wrote a doctoral thesis on the subject, proving that the high-order equations could be solved or, under certain special case situations, approximated, using standard Jedi meditation techniques.

Sense Powers

Instinctive Astrogation

Sense Difficulty: Moderate, modified by difficulty of journey.

Required Power: *Magnify senses*

Effect: This is the more well known ability of the Jedi to calculate astrogation routes without the use of a nav computer. The Jedi uses his *sense* skill to “feel” through the myriad hyperspace routes to determine the safest path.

The difficulty is modified by how dangerous the path is:

Task is:	Modifier (add to difficulty):
Very Easy	0
Easy	0
Moderate	0
Difficult	+5
Very Difficult	+10
Heroic	+15

If the Jedi succeeds at charting the course, the Jedi needs only make an Easy *astrogation* total to plot a safe path. If the Jedi fails the roll, the *astrogation* difficulty is automatically Very Difficult; if the roll is missed by more than five points, increase the difficulty to Heroic.

Sense Path

Sense Difficulty: Moderate

Required Power: *Emptiness, hibernation trance*
This power may be kept “up.”

Effect: This power tells a character what “path” he is on: whether his current actions are likely to lead him to the Dark Side, and whether any specified future actions are likely to do so (This power may be thought of as *farseeing* without *control*). Bear in mind that without *control*, the Jedi has no control over whether he sees the past, present or a possible future. The visions he receives are more likely to be allegorical in nature; to receive specific details, the *farseeing* power must be used.

When giving the results of this power, be honest but obscure: if the character has gained any Dark Side Points and is attempting to atone, this power will tell him how successful he is being within a game context.

The Jedi can choose to consciously use this power, or it can be a plot device. If the latter, at an appropriate point in the scenario, you may call for a roll on this power, and give the Jedi a

vision if he succeeds. You may use this to tell the players how well they are doing, or to give them a premonition of doom just before a critical encounter in order to heighten the game atmosphere. You may use it to warn them (by showing them what will happen if they continue their current course), to encourage them (particularly if they have done the right thing, but because of the way the scenario has been written they seem to have failed), to give them hints, or to foreshadow later events.

A vision from the Force should never be taken lightly by the players. It *should* give them something to think about, along with the attendant chances for some good roleplaying. Bear in mind that different Jedi will tend to receive different renditions of the same scene, and consequently you should “tailor” the details you give to fit the character concerned. Instead, you might consider altering the way you describe the scenery; for the Dark Side, you might always describe rocky and barren terrain, with a cold wind blowing, or alternatively it might always be night for the dark visions, and daytime or dawn for the light side. You can present these images in as contrary a manner as you wish, *provided that you are always consistent with descriptions*.

Another thing to bear in mind is that it is never easy to tell which is the right course to take (although the path of Darkness may be clear enough, the path of Light is far more elusive). The Jedi must still be sure to follow the Jedi Code regardless of what his visions seem to be telling him, otherwise his own desires will encourage a less truthful vision and cause his downfall. And it is quite possible for a skilled Dark Jedi to “twist” the readings of this power to suit his own ends.

Example: *A narration of a sense path vision. “You seem to be having some sort of strange vision. Mists swirl about you, and the scene is disorienting and unreal. You are walking across a featureless plain. There is a sense of foreboding in the air. Then you see Boba Fett, some way over to the right. He is walking straight towards you, at a measured pace, blaster carbine at the ready. The vision fades.”*

Example: *Another narration. “You are scrambling through a rocky landscape at night. The only light is a feeble glow ahead of you, coming from behind the next outcrop. You are hurrying, trying to arrive in time to avert ... something. When you pass the outcrop, the terrain falls away on all sides, and you find yourself on the edge of a gigantic precipice, like the inner rim of a volcano. Rock walls loom high on the opposite side of the pit. Standing, alone and vulnerable on a spike of rock scarcely half a meter wide at the tip, is*



your companion, Tetsu. He is scared and crying. The column he is on is nowhere connected to the rim where you are standing; there is no way to reach him. Then a wind begins to howl up from below you."

Example: *Another narration: "You are walking along a path; the path is straight and wide ... and black as coal. On your left is a second path, just as broad, just as straight, and shining brilliant white. You become aware of a presence, walking along the second path, matching you pace for pace. Some way ahead, your paths cross, and the path that leads away from your meeting is twice as wide as your own ... and of indeterminate color."*

Control And Alter Powers

Feed On Dark Side

Control Difficulty: Moderate when activated; Very Easy for each round thereafter

Alter Difficulty: Moderate when raised; no roll for subsequent rounds.

Required Power: *Sense Force*

Warning: Any Jedi who activates this power automatically receives a Dark Side Point.

This power may be kept "up."

Effect: This power allows a Jedi to feed on the fear, hatred or other negative emotions of others to make himself more powerful. It does not matter to the Dark Side *why* the others are filled with

dark emotion; the feelings alone suffice.

In game terms, in any round in which a character using this power is in the presence of a Light Side Force-sensitive who gains a Dark Side Point, the character gains a Dark Side Point and a Force Point. If multiple characters gain Dark Side Points in the same round, the character gains multiple Force Points. These Force Points must be spent within five minutes of being received.

This is a power that Dark Jedi use to gain power from the anger and hatred they cause in their foes. For player characters who are quick to anger, it is impossible to die-roll their way out of this situation. The only way they can stop a Jedi from gaining extra Force Points from this power is not to give in to the Dark Side. This can be extremely difficult, particularly as there is nothing to stop the Dark Jedi from doing everything in his power to provoke these negative emotions. This might include deception, butchering innocents, taunts, insults, threats against the characters, their friends, families, home planet or base, and anything else that is likely to make them call on the Dark Side.

Players who are unable to think of a better way of defeating a Dark Jedi than by brute force are very likely to be destroyed if faced with this power. Avoid overuse of this power, as it can severely disrupt game balance if not used in moderation.

Chapter Eleven News Agencies

The *Star Wars* galaxy is one where access to information is vital. With a civilization that spans millions of systems and countless quadrillions of beings, there is a compelling need to have accurate information as soon as possible. With the Empire's stranglehold on the HoloNet, often the fastest way to get information from one spot to another is courier (of course, there are subspace radio networks, but there is considerable lag time over long distance broadcast). For the average citizen of the galaxy, however, there are the news agencies. They have resources to gather information all over the galaxy, although most are under considerable regulation from the Em-

pire. Still, an overview of some of these agencies, and how their policies affect the perceptions of the general citizenry, is in order.

TriNebulon News

TriNebulon News covers about a quarter of the Outer Rim Territories, including Parmel, Quence and Portmoak Sectors. TriNebulon broadcasts holovids on several subspace bandwidths (though communication isn't instantaneous; there is usually some delay in the outlying areas of its broadcast sphere). The network's style can politely be described as "tabloid." It is fiercely pro-Imperial and ridicules those with views that aren't in keeping with the Empire's pro-Human and intolerant attitudes. TriNebulon also makes a lot out of the fact that it has "correspondents in far-flung corners of the galaxy, there to ensure that *you* get to hear about the *important* issues *first*."

The fact that these far-flung correspondents rarely write about anything more important than the night-life, the weather and what *outrageous* fashions exist in their corner of the galaxy appears to have eluded both TriNebulon's editors and its viewership. These "far-flung correspondent" jobs are regarded among journalists as some of the cushiest in the business.

NovaNetwork

Everything that applies to TriNebulon News applies equally to its arch-rival, NovaNetwork. NovaNetwork also has some other tricks of its own. For one, anything that can be trademarked *is* trademarked. Also, the network manages the difficult juggling trick of being pro-Imperial *and* being tolerant and in favor of individual rights — a confusing and schizophrenic editorial policy. The two networks cover virtually the same territory, and whenever one of them makes a factual error on reporting something within that area, the other can be relied on either to ridicule the "shoddy reporting" of its "lesser competitor" or

Scenario Hooks

News agencies can be used as scenario hooks in several ways. The most obvious way is to have the characters' interest grabbed by a holovid report, and then either have them sent to investigate or let them go under their own steam.

The Rebel Alliance tries to scan at least some of the vast amounts of data generated by the galactic media (a job usually performed by the Analysis Office, Intentions Branch, Alliance Intelligence), but generally has more important things to allocate its resources to. The Alliance is also aware that the Empire occasionally plants false information in order to catch the Rebels.

In general, scenarios generated by this method should be pretty low-key or unconnected with the Empire. Try some corporate shenanigans for instance ...

A second possibility is to have the characters come across an intrepid roving reporter working for one of the networks. Reporters are often even better than characters at getting into trouble, so there is no knowing where this kind of hook could lead the characters.

A third option, primarily intended for a tramp freighter campaign, is to have an agency commission the characters to take an important datafile back to the regional office for publication. The hook here will probably be that someone doesn't want that information published ...

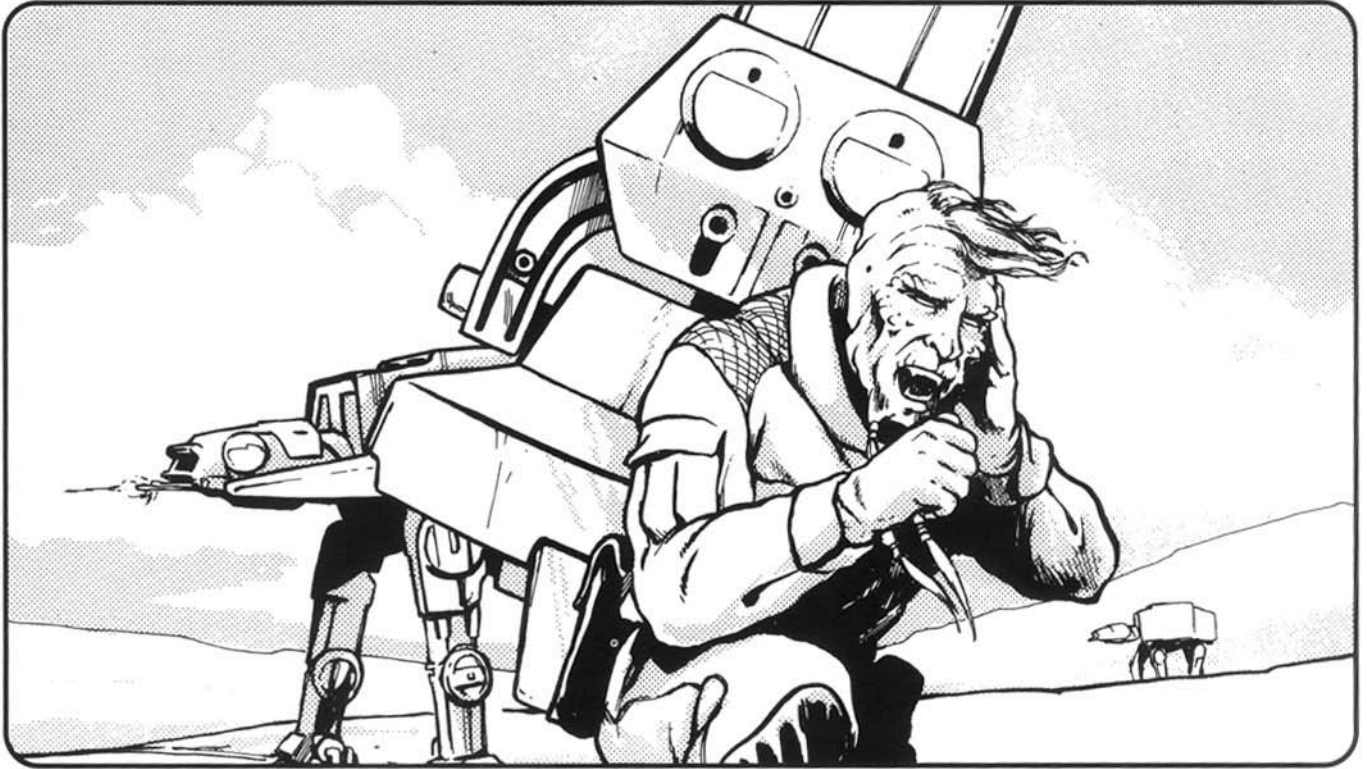

alternatively to come up with an even wilder inaccuracy of its own.

Sektor 242 NewsLine

This is a much smaller news agency than the TriNebulon and NovaNetwork, and it attains far higher standards of accuracy and objectivity. It has a mild pro-alien and individual rights slant (it is one of the few agencies to admit that all sapient beings are “people” instead of just Humans) and a generally thoughtful style of prose; its political commentaries are highly respected for their conciseness. The network’s major difficulty is economics, where its commentaries are often far wide of the truth.

The network also syndicates one of the ten most popular animated holostrips on the Outer Rims main disk — “The Times and Trepidations of Majnar Roak.” This bewildering series is either a simple, straightforward story of the trials and tribulations of a retiring finance clerk on a backwater world, or a mildly excoriating satire on the state of Sarin Sector (Sector 242) itself. Sometimes it is *really* hard to tell.

Imperial HoloVision

Imperial HoloVision is one of the largest, most powerful news agencies in the galaxy. In the days of the Republic, it was called Republic News; when Emperor Palpatine took over, the company was reorganized, given an Imperial warrant, and

more or less passed back to its old management. There are a few COMPNOR “observers” within the organization, and some managers have been displaced, but the company actually needed very few changes to get it to conform to the Emperor’s requirements. Under the Republic, it had remained sufficiently independent that it was able to show at least some of the flaws of the crumbling Old Republic; all the Emperor’s servants needed to do was to blind it to the short-comings of the New Order. This has been relatively easy to achieve.

It is a rare planet that is not within HoloVision’s broadcast sphere. Since the dismantling of the HoloNet, the simple logistics involved in distributing the company’s latest news releases across the galaxy are mind-boggling. In fact, the company now spends *more* on collating and distributing its material than it does on gathering its stories. Imperial HoloVision is pro-Imperial (naturally), pro-business and in favor of individualism, but not in favor of government protection and supervision of rights. Its reporting style is detailed, sophisticated and mostly accurate. It doesn’t distort the questionable policies of the Empire; it simply ignores them, therefore making sure that most of the galaxy’s population never hears about atrocities. It is respected and trusted, and perhaps one of the most powerful propaganda tools the Emperor possesses, even if its executives aren’t on the Imperial payroll.

Galactic Weekly NewsStack

Galactic Weekly NewsStack has proven to be a major thorn in COMPNOR's side. The *NewsStack* began as a counterculture publication, downloaded into various public domain computer networks. Instead of dying a quick death, as COMPNOR predicted it would, *NewsStack* was passed from network to network, sector to sector, receiving much wider dissemination than COMPNOR dreamed possible. Since then, the Imperial censors have worked very hard to stop the spread of the *NewsStack*. Unfortunately, they have achieved very little success in their endeavors.

The *NewsStack* acts like an old-style virus program, insinuating itself into the broadcast spheres of virtually every computer and holo system around, including (occasionally) the broadcasts of the larger news networks. On pre-programmed dates, the *NewsStack* programs override a computer's operating system and present themselves to computer operators. The rumors have been known to show up on computer networks, business computers, holonews broadcasts, and anonymous sources have confirmed that *once* a posting ended up overriding the command controls of an Imperial Star Destroyer while on maneuvers in the trinary Septevorres System. The override function caused the Star Destroyer to drift into one of the suns ...

COMPNOR's programmers are trying desperately to root out the *NewsStack*, but so far they have met with no success; the editor and his staff are all expert programmers, apparently. The *NewsStack* appears to be the product of young, enterprising computer operators in the Outer Rims with entirely too much free time on their hands. Their irreverent brand of humor and com-

plete disrespect for authority (in any form) has resulted in them being banned by the Empire's COMPNOR Art group. Their satire has enraged the Empire's top leaders, Rebel Alliance command and most of the major corporations in the Known Galaxy. Naturally, this has made the *NewsStack* exceedingly popular throughout the Empire.

The editor of the *NewsStack*, who writes under the pseudonym Palpatine II, has proudly stated that he is "rabidly anti-Imperial, anti-corporation, and anti-Rebellion. We're anti-*everybody*." The publication is scathing in its criticisms (particularly of the Empire). Irreverence is another feature of the *NewsStack*: the arts correspondent writes under the pseudonym "Ars Dangor, advisor to the Emperor" as he reviews banned rock groups. Despite the decision to make *any* subject grist for the humor mill, it has proven surprisingly popular, especially among adolescents and young adults who tend to like such pointed commentary, even if they are on the receiving end. It is satire at its finest, and is driving COMPNOR crazy ("Which *proves* that the Empire has absolutely *no* sense of humor," says *NewsStack* editor "Palpatine II").

Of course, COMPNOR is the only Imperial group that is really willing to devote much time to this: the military and Imperial Intelligence are far too busy trying to prevent the Rebellion from spreading. However, it is believed by some that members of the *NewsStack* are secretly Rebel sympathizers and bury certain select bits of information within their dispatches, which can then be deciphered by Alliance intelligence personnel. The *NewsStack's* response is "Anything for publicity."

Galactic Weekly NewsStack:

Banned by the Empire and Loving Every Minute Of It!

- 21.05 Luke Skywalker is just an Alliance public relations exercise. DataPage 18732
- 25.02 Rebel Special Operations Team steals Mandalore Sector. "Where are they keeping it?" asks baffled Moff. DataPage 19928
- 26.12 "Oink" is a deadly insult in Gamorrese; Moff Balfour inadvertently starts clan war. DataPage 20177
- 26.13 Reporter identifies site of AT-AT stud farm. Pictures on DataPage 33123
- 28.08 Imperial Royal Guard foils attempted theft of Palpatine's left leg. "I'm hopping mad," says Emperor. DataPage 23671
- 29.91 Due to a bookkeeping error, three Imperial-Class Star Destroyers have inadvertently been reclassified as comlinks, and are now on sale as Naval Surplus at twelve credits apiece. DataPage 44903
- 30.25 TechNotes, Volume 17: The SoroSuub RIP-17 Autochef series can be modified to produce:
- a) food (though this requires more time and effort than you would think).
 - b) detonite (which is what the autochef claims is "food").
 - c) high-quality spice liquor (Just kidding! Apologies to all you Corellians who fell for this!). DataPage 00834
- 36.61 Sector Moff mutters insults behind Lord Vader's back; is demoted to corpse almost instantly. "That Vader, he kills us," say Imperial Personnel officers. DataPage 24722
- 37.11 Rebel Security foils unauthorized cloning attempt on General Madine. "I'm beside myself," says General. DataPage 13904
- 37.82 Boba Fett is actually a green, scaly humanoid about 25 centimeters tall. He controls his armor via a complicated system of levers, pulleys, and bits of string. DataPage 83400
- 37.91 Retraction: The editors would like to apologize to Mr. Fett for the above item, and ask that he please quit shooting our reporters. DataPage 83401
- 38.94 Jabba the Hutt to start fast food chain, named Rancor's Nibblepit. Debt defaulters are encouraged to help supply primary ingredients to daily specials to help pay their debts to Jabba. DataPage 46902
- 39.67 Retraction: The editors would like to apologize to Jabba the Hutt and to the next of kin of several of his debtors. The preceding piece should have read: "Debt defaulters are the primary ingredients." We would also like to ask the next of kin to quit whining about it, already. The meals ... sorry, debtors ... in question were deadbeats, anyway! DataPage 46904

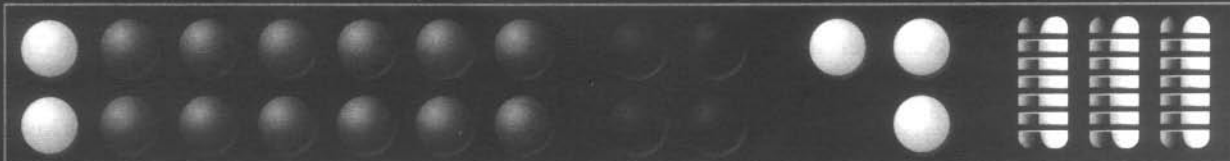

Chapter Twelve

Leisure Activities

"No liability is accepted for injuries or illness resulting from sampling items on the following drinks list. Customers are advised to check for species compatibility before ordering."

— Sign at Margath's on Elshandruu Pica, Quence Sector

The high technology of the *Star Wars* galaxy allows the production of some thoroughly weird and wonderful beverages, which can be used to spice up "cantina sequences" of adventures.

Lum

A particularly powerful beverage, favored mainly in and around Corellian space, but known throughout the galaxy. It is often used in a drinking competition known as "lumguzzling," described in the adventure *Tatooine Manhunt*. The rules are simple.

Each player drinks a pitcher of lum, and then makes a Very Easy *stamina* roll. If he fails, he immediately passes out from the potency of the drink. If he succeeds, he remains conscious. The catch is that his *stamina* code is now reduced by 1D, and when the world has stopped lurching from side to side, he will have to make a second guzzle. This process continues, with each side taking turns to guzzle, until only one person remains conscious. Presumably if both parties collapse on the same turn, the game is a draw. A pitcher of lum is usually quite large (costing 6 to 10 credits), and in smaller quantities the drink tastes sweet and slightly soapy (but not unpleasantly so).

Lum has peculiar effects on a body — while the imbiber often feels the effects of more standard forms of alcohol, for some reason, a drinker cannot overdose on lum as he can with other types of beverages. Therefore, lumguzzling isn't nearly as dangerous for the participants as other types of drinking games are.

Renan Irongut

This drink is named simply enough after what you need to drink it. (Downing it in one drink requires a Moderate *stamina* roll!) Tradition has it that the potion also makes a potent rust remover. However, as this drink costs around 3 to 5 credits a shot, it's much cheaper to buy real rust remover and use that; so far no-one has gotten around to testing the brewer's claims.

Elshandruu Pica Thundercloud

This mixed drink has been likened to watching a starfighter flying towards you from the horizon: you can see it coming ... you see it flash overhead ... there is a brief pause ... followed by an almighty and completely unexpected explosion of sound as the shockwave passes. At this point, the drinker should make an Easy *stamina* roll or fall off his seat from the impact.

The name "thundercloud" arose because the active ingredients of the drink produce a "fizzy" effect which creates a miniature cloud of ionized gas above the mouth of the serving glass. Most establishments serve this drink in a container that fires tiny microshocks into the cloud, simulating an electrical storm.

Pink Lizard Thunderbolt

An interesting variant on the above. For added realism, the drinker can taste the mud from the ground after being knocked over by the sound wave. At this point, roll a Moderate *stamina* check to avoid falling over.

The drink is named after its inventor — a small, scaly lizard of indeterminate species, gender and color (most people who have tried the drink had difficulty focusing their eyes afterwards) who popped up in one of Margath's bars off and on for a number of years. After inventing this potion, it never drank anything else, and the brew was eventually named in its honor.



Starshine Surprise

This drink is called the Starshine Surprise because, after you've drunk it, the next thing you will notice is the stars above you, probably because you are laying flat on your back in the street (which is quite a surprise if you're not expecting it). This drink is only for non-Humans and the most hardened of Human drinkers.

Tatooine Sunburn

Tatooine is a binary system; a Tatooine Sunrise is two Starshine Surprises in the same glass. Don't *ever* try a Cassandra Sunrise (it is rumored that one of these makes an excellent sunburn salve, but only if you have *extremely* thick skin).

Skannbult Likker

Skannbult Likker, a brew unique to the planet Skann in Astal Sector, is possibly the most volatile fire-water in the galaxy. It is made from local surplus crops (Dust-Corn and Dry Gene Wheat), and distilled in rock basins by the local farmers. However, the Likker's quality is very variable, and the good stuff is only brewed by the smaller farmers way out of town. Traders rarely encounter anything but the quick-brewed rotgut on offer at the Skann spacers' bar. Margath's on Elshandruu Pica has recently laid in a small supply of the good stuff, but Kina Margath, the proprietress, is far too good a businesswoman to

reveal where it comes from or her supplier. On Elshandruu Pica, the drink is simply called Fire Liquor, and retails at between 15 and 25 credits for a double measure. It is still selling fast, and Margath is likely to raise the price to 20 credits for a single in the near future.

Daranu

Another obscure drink, this time from Parein II 4 in Sarin Sector. Daranu is made from a local fruit called Terrberries and certain spicy nuts, and is fermented in drilled, scooped-out hardnut shells from Parein Sweetgreen Fruit. It is rich, refreshing, warming, and hits you like a well-aimed blaster shot about half an hour later.

The Reactor Core

Many hardened drinkers claim that this beverage should only be available by prescription, mainly because of the quantity of narcotic agents that are released by mixing Spice Liqueur and Blue Tonic. The people who drink it claim that this is complete nonsense, no narcotic agents are released and ... by the way, did you know you've just turned into a lampstand?

The Meltdown

Supposedly a more sophisticated drink than the above, the presence of Lum and Spice Liqueur in close proximity means this drink doesn't

need to release narcotic agents to have exactly the same effect as the more conservative brew just described. The drink is much more expensive, however; typically ten to 12 credits.

Corellian Whisky

The Corellians have, for all practical purposes, sewn up the galaxy's whisky market, both on the manufacturing and consumption sides (anyone who has seen just how much whisky the average Corellian consumes will agree with the sentiment). Not many other people buy the stuff, anyway. It may be good quality, but because of the cost of importing it from the Corellian System itself, most people consider it too expensive to drink on any but the most special occasions.

Savareen Brandy

There is a lot of snobbery associated with the consumption of quality brandy. Savareen and Cassandran brandy are probably the only types actually worthy of all the arcane procedures that dedicated brandy drinkers like to indulge themselves in. As far as anyone else is concerned — yes, they're "quite nice."

Cassandran Choholl

Their brandy may be good; their Choholl is better. Grada brand Cassandran Choholl is particularly sought after throughout most of the galaxy, and often sells for upwards of 500 credits per bottle.

Other Drinks

Every inhabited planet in the galaxy produces intoxicating drinks of some kind. The ones described above are a small selection of the best-known. The dedicated may find Renan wines, Ky-Lessian Fruit Distillate, Orryxian Catsblood, vintage Bespina Port, Spice Liquor, Ottegan Mead, even Narcolethe from the Mandalore system and Endrolian ground-apple juice (which isn't supposed to be alcoholic, but which often ferments during storage). There are drinks brewed from plants, drinks brewed from trees, even one brewed, with the help of some particularly powerful bacteria and an unusual planetary atmosphere, from solid rock!

If the delights of the galaxy's spirits pall, there is plenty of good honest beer to be quaffed. Fozbeer, Fox Beer (not as bad as it sounds), Ryll beer, spice beer, Thuris Stout, lagers, fortified beers, ciders and so on. The only limit is your liver's ability to endure the search ...

Bars And Clubs

The *Star Wars* galaxy is littered with bars and clubs of all sizes, shapes and descriptions. For instance, Quence Sector boasts *millions* of bars and clubs. A notable spot is Margath's on Elshandruu Pica, a top quality hotel, conference center, galaxy-renowned casino, and drink emporium, all under the same roof. On a quiet day, there might only be 10,000 people in the place. On a busy day, 50,000? 100,000? Only Margath, the proprietress, has ever managed to keep track.

Similarly, Bospin has clubs, bars, casinos and hotels — more than one would think for a mining city. Some names: The Bospin Grand Hotel (with casino and bar), The Rahama Club, the Skyreach Hotel, Amici's, the Tibanna Club, Ilona Hotel, The Silver Arch Hotel & Casino, the Farris Wheel, the CMG Guildhouse ...

Hotel Chains

Galactic travellers will frequently encounter hotels with the same names and styles of decor on a number of different planets. Chief among the hotel and casino chains of the Rim Sectors are: the Farris Wheel casinos, the Grand Hotel (almost *every* planet has a Grand Hotel on it somewhere; it won't necessarily be part of a chain, but it'll be there nonetheless), the Spaceport Bar, the Spacer's Bar (no surprises here, but the same principle applies), the NonHumans Inn (these clubs cater to the whims of aliens), the Nebula Hotel (again, a common name), Corellian Merchants' Guildhouses, Shadiru, the Pelnic Clubs, Lantillian Spacers' Brotherhood Guildhouses, and so on.

Luxury Liners

Luxury liners usually have all the facilities available to ground-based bars, restaurants and casinos, with the added twist that they travel around the galaxy, giving their passengers opportunities to sample the nightlife and culture of scores of worlds without having to go through the bother of commuting. To illustrate: Rim Riders' Travel Associates, one of the agencies arranging trips for Core Worlders on middle-market liners, once ran an extremely successful advertising campaign using the caption: "Stay still, and we'll bring the Galaxy to you." If you can afford it, liners really are the only way to travel.

On which subject, there now follows a small selection of luxury liners that characters may be likely to encounter in the Outer Rims or other regions of space.



Culroon Minstrel

The *Culroon Minstrel* is a *Jesoni-class* liner currently operating on the LeisureCorridor from Coruscant to Ebiwaan. The liner's clientele used to be predominantly 50- and 60-year old Core Worlders out for a relaxing cruise to the Middle Rim and back, and the staff were a little superannuated, too (it made the passengers more comfortable). After the famous armed altercation between Zardra and Dharus, a lot of younger people started travelling on the ship for the hint of danger that the episode has marked it with. The older staff found this very trying to begin with (though they were far too professional to show it), but eventually those that couldn't take the pace retired or otherwise moved on, and the liner recruited new, younger staff to match the new passengers. The ship now buzzes with activity from shuttle launch to landfall.

O.S.S. Telira

"O.S.S." stands for "Osman Shrier's Starship" (Osman Shrier being the captain and owner of this particular vessel). The *Telira* is a Corellian Corvette fitted for duties as a passenger liner. *Telira* may not be the classiest of transports, but her prices are correspondingly lower and her staff are usually friendly and helpful. And Captain Shrier is a bit of a clown without meaning to be (he is short, fat, and has piggy eyes), but his charisma has meant that many passengers who might otherwise have found the quality of ser-

vice on the vessel a little low (*Telira* has only a 3-star rating) often return, if only to see what he will get up to next.

O.S.S. Telira is currently on a 10-day regular run between Elshandruu Pica, Parmel Sector capital, and Quence Sector.

Veil of Skynara

The *Veil of Skynara* is a luxury space yacht, built in the Vensor system, and is currently running cruises and shorter trips along the Five Veils' Tour trade route, which runs from Farstine, the methane world, to Skynara in Skine Sector. Until very recently, Rebel warships were so common in Skine Sector that the ship currently receives an Imperial escort for the final stages of its journey — just to be on the safe side. Passenger numbers haven't really begun to pick up, yet.

There is also a famous Balved Sculpture called the Veil of Skynara; this is currently located on board the luxury yacht just described, after being obtained for an astronomical sum. This ship is a very high class transport indeed; among the most expensive vessels in the galaxy having such a valuable work of art on board isn't as uncommon as you might think.

Other Ships

There are hundreds of other luxury liners out there, covering all conceivable routes and all budgets. Other vessels that are reasonably well-known in the Outer Rim include the *Y'Dar Prin-*

TRAVEL THE LUXURIOUS

UOHAI

U N I R A I L

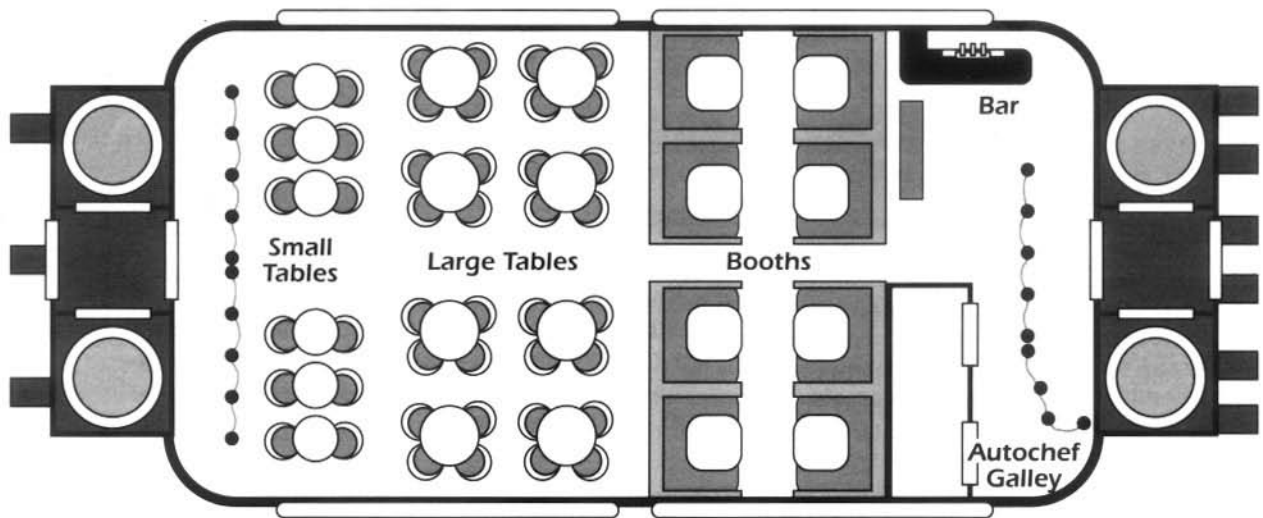

DINING CAR (Upper Level)

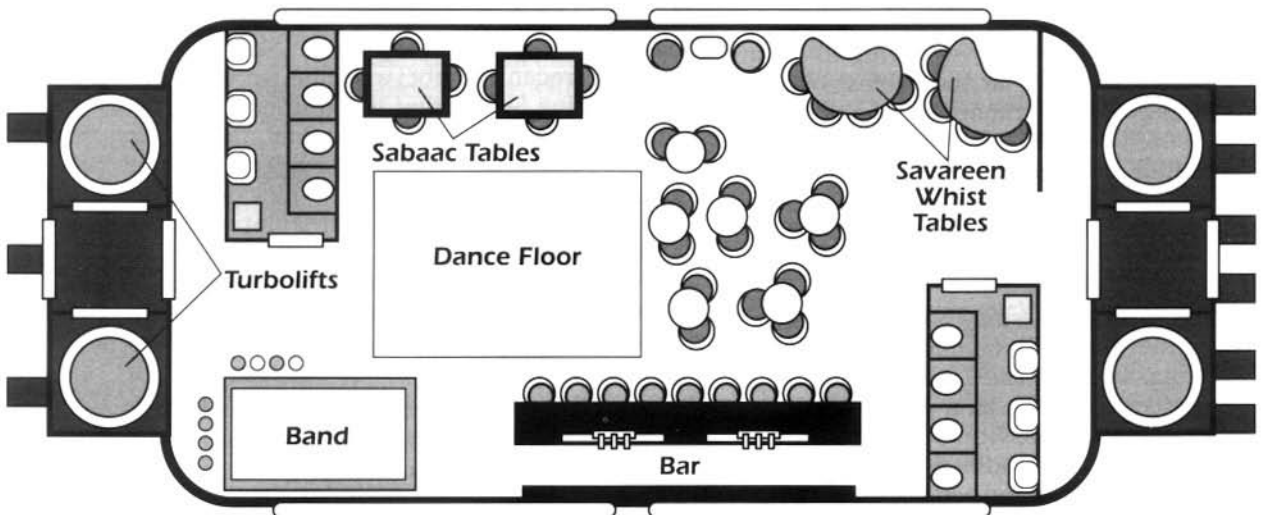

CASINO (Lower Level)

SIDE VIEW

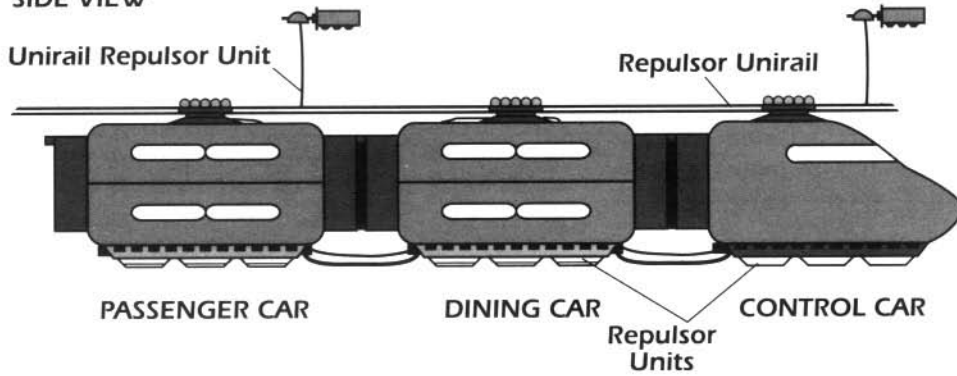

TOP VIEW

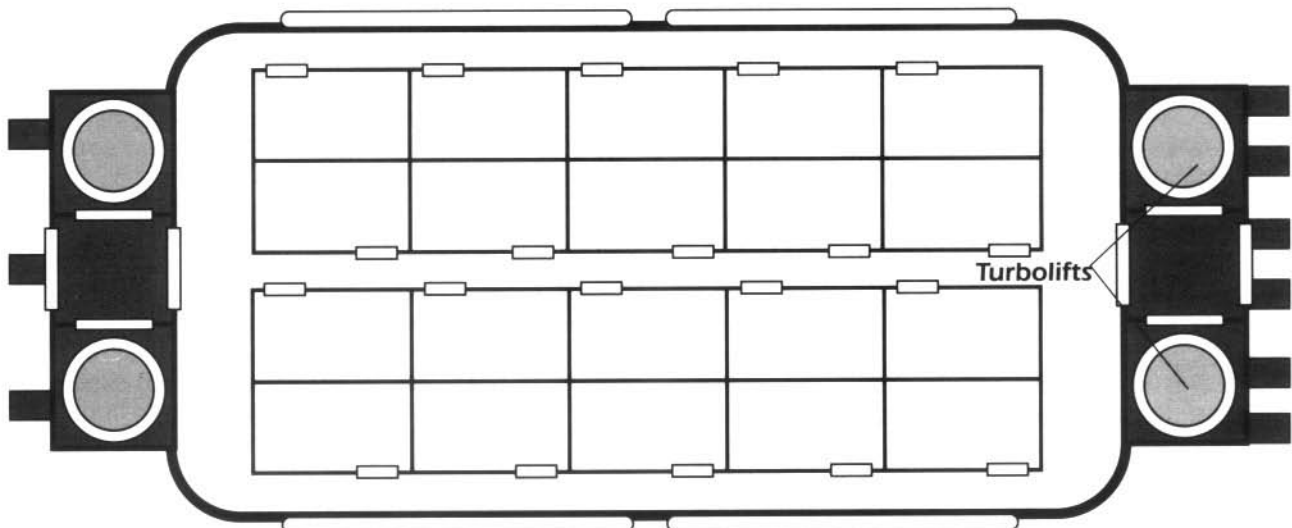
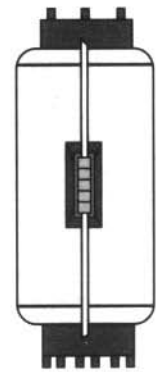

UPPER LEVEL STATEROOMS (Passenger Car)

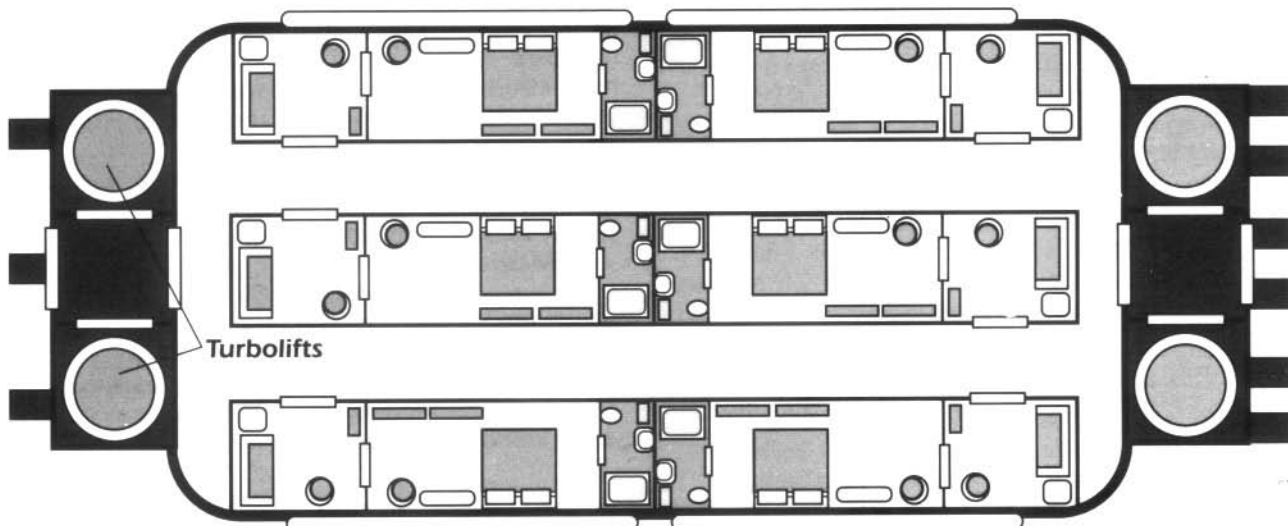

LOWER LEVEL SUITES (Passenger Car)

cess, Savareen Dancer, Lady of Whinnedor, Falcor's Runaway and Queen Aelnari.

The Vohai Unirail

One of the more interesting forms of transportation can be found in Parmel Sector, on the planet Vohai (or rather *above* the planet). The Vohai Unirail is a form of transportation based loosely on the super-conductive monorail technology found on lesser technology worlds, but the system is much more sophisticated than the name implies.

The unirail track is a suspended cable of super-conductive wire, strung roughly two kilometers above the surface of Vohai, held aloft with repulsorlifts, circling the entire planet from pole to pole. Each car is also equipped with several redundant repulsorlift units in the event of an emergency. To date, the unirail has a perfect operational safety record.

The unirail consists of a control car and 45 cars, each linked together. The unirail has 34 passenger cars (containing suites and state rooms) and 11 dining/casino cars.

The unirail is famous for its spectacular views and sunsets, and is popular among the affluent, who often pay the outrageous ticket price to board simply to impress other affluent people. A travelling vacation on the unirail (one week) costs 6,500 credits *at a minimum*.

Since Vohai is relatively remote, the unirail is often used as a letter drop or contact point for both the Rebel Alliance and the Empire. Intrigue tends to run rampant aboard the unirail.

■ The Vohai Unirail

Craft: Modified Kuat Drive Yards' Model 10-T monorail

Type: Luxury Transport

Scale: Speeder

Length: 1,150 meters

Skill: Vehicle operation: Vohai Unirail

Crew: 100, skeleton crew: 25/+10

Passengers: 1,500

Cargo Capacity: 3 metric tons

Cover: Full

Altitude Range: 2KM

Cost: Not available for sale

Maneuverability: 0D (must follow "skytrack")

Move: 30; 90KMH

Body Strength: 3D

Chapter Thirteen

Music

Music has traditionally been important to most cultures, and the *Star Wars* universe is no different. Of course, with a galaxy-wide economy and a very restrictive government, music is very commercialized and controlled.

While particular artists will be very popular on some worlds and unknown in others, and different styles of music will be wildly popular on different planets, the following entries can be considered to be uniformly popular (or at least familiar) throughout the Outer Rim Territories.

It is important to note that the Imperial Board of Culture reviews every musical track that is released to the galactic distribution nets. Any tracks the group considers worthless or offensive are given a "scarlet" rating; particularly dangerous (anti-Imperial) tracks are banned outright.

The Emperor's New Clothes

This band is loudly and obnoxiously pro-Imperial, so much so that the Imperial Board of Culture (COMPNOR's Art Group) was initially unreservedly complimentary about its early releases. But it rapidly became clear that there were two completely distinct types of people who listened to the band's music: those who believed every word the band said, and those who believed the exact opposite, and the Board rapidly toned down the enthusiasm of its reviews. The first group of listeners includes many members of the Imperial military and COMPNOR, and many Core Worlders; the second group includes everyone from traders and smugglers to pirates and swoop gang members. This tends to make the band's concerts interesting (not to mention dangerous) places to be. It is a matter for public debate which of these two categories the band members themselves fall into.

Works released to date:

"Artistic Integrity" (Latest Release)

Includes title track, "Section 223," "Death Star Rising," "For the Love of Beau TIE."

"Totally Patriotic" (Compilation)

Includes title track, "The New Order," "Supremacy," "Star Destroyer," "Defending Your Freedom."

Red Shift Limit

A peculiar mix of techno-rock and ballads, *Red Shift Limit* are now well known for their highly anti-Imperial flavor and mesmerizing instrumental tracks, and several *very* unflattering songs about certain institutions and personages, including Moff Balfour, Darth Vader, Boba Fett and the Emperor himself.

The group is actually an arm of a renegade underground holo network (though very few people know this), and its line-up of musicians changes constantly depending on who is available at the time and who wants to record a new track. As a result, the group has a very wide and constantly expanding musical repertoire.

Occasionally they re-record their own (and other people's) old tracks under a different set of artists, though these new versions are usually changed so much that they become new songs in their own right. A recent victim of this treatment is *T.E.N.C.*'s track, "Totally Patriotic"; *Red Shift Limit*'s rendition gives the song an entirely new meaning clearly *not* present in the original version.

"Totally Patriotic" (Latest Release)

Includes title track (cover of *T.E.N.C.*'s hit), "Love in the Ruins" (scarlet), "Reverse Thrust" (instrumental), "Lady Nebula" (scarlet).

"Dangerous Dreams" (Compilation, banned)

Includes "Dangerous Dreams," "Imperial City," "Binary Cantata," "Lost Voices."

"Limited Warfare" (Compilation, banned)

Includes "Limited Warfare," "Desert Starlight," "Armored Heartbreak," "Masslines," "Bureaucracy Blues," "Four Dimensions," "Cloud."

"Thoughts From The Core" (Compilation, banned)

Includes "Flameout," "Road to Mandalore," "Armored Heartbreak," "Sunny Side of Ryloth," "Permission to Think," "Permission Denied," "Take Them On."

Boba Fett and the Assassin Droids

This is a new group that has only just begun to make inroads on the galactic music market. They are the galaxy's original talent-free band and they are steadily gaining a cult following. A lot of alien species seem to like them (for no readily discernible reason), and only time will tell if the real Boba Fett will object to his name being used in this way; it seems unlikely that he will even deign to notice the band.

As yet, *Boba Fett and the Assassin Droids* have released singles only, though they have threatened to release an entire album in the near future.

Works released to date:

"IG-88, Where R U?"

"Blow 'em All Away" (banned)

"If You're A Biped, I Can Make U Limp"

"Who Cares (If Freedom's Gone)?" (banned)

Starburst

More "mainstream" than *Red Shift Limit* (mainly because they haven't been banned yet), *Starburst* also has a more restricted range. Though thoroughly disapproved of by the puritanical New Order, they had been staying away from overt political messages. However, they have now started to take advantage of the freedom of speech that is still in place on many of the Core Worlds to spread their opinions, and their latest releases have begun to take on a subtle anti-Imperial slant. Indeed, several of the tracks in their second album, "Only in Your Dreams" have been rated scarlet (restricted, possession of the material may be deemed a misdemeanor offense, at Imperial discretion) by the Imperial Board of Culture. Until recently, *Starburst* had been spending most of their time performing in the Core regions, where they have grown in popularity after their first scarlet rating for a song, but they are currently on a tour of several Rim sectors.

Their second album has only just been released, and it is still causing a great deal of controversy across the galaxy. One of the reasons behind the success of this compilation is the way the tracks have been recorded in a chronological order: "Only in Your Dreams," followed by "Cold Dawn" and so on. While the tracks taken individually do not appear to have any great significance, as a whole they paint a very damning picture, and the Board of Culture came close to banning the album as a result.

Starburst vehemently denies that the order of the tracks is anything more than simple coincidence; few people are convinced.

Works released to date:

"Only in Your Dreams" (Latest release, scarlet)

Includes title track, "Cold Dawn," "Death or Glory," "Life in the Big City," "Liberty Road," "End of the Line," "After the Old Life," "Diamonds."

"StakeOut" (Compilation)

Includes "StakeOut," "Making Lives," "Static," "Go Home," "Soul for Sale" (scarlet), "Hyper-shunt," "War of Words," "Deadly Vision."

Annadale Fayde

Annadale Fayde is probably best described as a rock balladeer. Her tracks are often melancholy and always very acutely observed. She travels around from band to band, or more accurately keeps changing her musicians around, and she is rumored to be very hard to work for. This is almost certainly because of the extremely high standards that she sets both herself and her backing group. On stage, she sings alone, with the band in the shadows.

Works released to date:

"Darkness on the Land" (Scarlet, latest release)

Includes title track, "Emotional Hostages," "Jewels," "Night is a Curtain," "Slow Dancing Star," "Lonely Heart Spaceport," "City of Glass."

"Emotional Hostages" (Compilation)

Includes title track, "Burning Bridges" (scarlet), "Cybernetic Love Affair," "Running in the Dark."

Deeply Religious

Deeply Religious are the definitive "banned" rock group. Their tracks are usually fast, exhilarating and cynical (and sometimes surprisingly melodic), and their breathtaking disregard (bordering on contempt) for the precepts of the New Order has made them as illegal now as they once were popular. Like *Red Shift Limit*, the best place to obtain copies of the group's music (and bootleg holos of its recent concerts) is on the black market. Note that possession of banned holos is a major offense and carries a fine of 500 to 1,000 credits along with confiscation of the offending material.

Works released to date:

"Ooh, It Bites" (Single, banned)

"Deeply Religious" (Compilation, banned)

Includes title track, "Torch Song," "Just Another Art Form," "Freedom of Speech," "Twi'lek Dancing Girls," "Saving the Universe (Again)," "Gamorrean Hard Case."



“Emperor of Air and Darkness” (Banned)

Includes “Lost Promise,” “Ancient Republic,” “Speeder Bike Races (Speed Kills),” “Moff Balfour’s Lament (Tapmint Surprise).”

“Advanced Explosives Handbook” (Banned)

Includes “Having Fun with Detonite,” “Rotten to the Core (Empire’s Crumbling),” “Heavy Blaster Blues,” “How to Get Banned (Have A Mind),” “Where Is Everyone?,” “How Do They See, Anyway? (Stormtroopers’ Dilemma),” “So Much for Tact.”

Sound Slugs

The data storage capabilities of memory cells almost defy description, and with the data compression techniques commonly available, a single storage unit the size of a blaster power pack can contain the complete library of even the most prolific bands. Consequently, the data units are also packed with other information to fill up the spare capacity. This commonly includes music holovids, reviews, interviews with group members, words to the songs, remixes, technical analyses of the sound profiles and so on. All of these different filetypes are stored to standard formats, and as a result, the same data cartridge can be read on a number of different media, including conventional computers, datapads, holovid machines and audio stacks.

Most sound systems in the Empire are able to produce sound frequencies ranging from hundredths of a cycle per second up to millions of cycles per second. Once these frequencies have passed outside the threshold of hearing, they can produce some disturbing effects, from euphoria and aggression to panic and so on. It would be quite possible for an unscrupulous band to exploit these effects to boost sales. There is an added danger in that these very low and very high frequencies can affect different species in profoundly different ways. As a result, there is a legal maximum amount, measured in both time and decibels, that these effects can be used for, and all public performances of all music groups are monitored to ensure compliance.

In fact, these measurements are often performed by various reviewers present; a typical gig “write-up” would usually contain a straight review of the actual performance and a separate breakdown of the subliminals used, covering

Latest Developments: The Emperor’s New Clothes versus Deeply Religious

— From the *Galactic Weekly NewsStack*

The Emperor’s New Clothes was rather needled by the two tracks on *Deeply Religious*’ first compilation — “Torch Song” and “Just Another Art Form,” and they responded with a very pointed track of their own, entitled “Artistic Integrity.” The gist of this track was, “We’re artists just like anyone else, we operate under the same freedom of speech laws as you do, and if you don’t like our material that’s just tough.”

Deeply Religious has responded in kind, with a nasty little track called, “Ooh, It Bites.” Meanwhile, the Imperial Board of Culture is making bewildered noises on the sidelines, because since the latter group was banned, the Board no longer investigates their material, and as a result it is only hearing one side of the argument. This one looks likely to run and run ...

— “Ars Dangor” (pseudonym),
Arts Correspondent

audio, visual, tactile and so on. These technical write-ups are often written by (and appeal to) technophiles, and it is rare for anything to be missed. Rather than be considered ominous or sinister, everyone knows that subliminals are used and they are simply considered a part of the show.

Not all sound slugs are filled with reviews and holovid files; some just store music alone. As a consequence of this, a single cartridge can comfortably contain an entire music collection. When the owner wishes to add a new track to his repertoire, he need only buy the track concerned, at a cost of approximately one to three credits, and the shop can then download it to his existing stored collection in a matter of seconds. A compilation of tracks can usually be bought at a discount; those albums listed above that haven’t been banned can generally be obtained for around six to ten credits each.

STAR WARS

GALAXY GUIDE 9

FRAGMENTS FROM THE RIM

by Simon Smith and Eric Trautmann

A compendium of trivia, news, rumors and information from the Outer Rim Territories. Inside this *Galaxy Guide*, there are countless new characters, ships, aliens and locations to populate your campaign. Meet some of the most famous Rebel heroes, Imperial despots and dangerous pirates and smugglers in this section of the galaxy.

This *Galaxy Guide* provides gamemasters with a wealth of information about life in the *Star Wars* universe, and includes chapters on the Rebel Alliance and the Empire, swoop gangs, mercenary units, pirates, corporations, media organizations, the Force, and even music, social life and culture! The perfect supplement to add atmosphere and flavor to your *Star Wars* game.

A STAR WARS
SUPPLEMENT

For gamemaster and one or more players.
For ages 12 and up.

©, TM & © 1993 Lucasfilm, Ltd. (LFL). All Rights Reserved.
Trademarks of LFL used by West End Games under authorization.



40063

0-87431-192-6 \$15.00

